

SFI SYSTEM DESCRIPTION

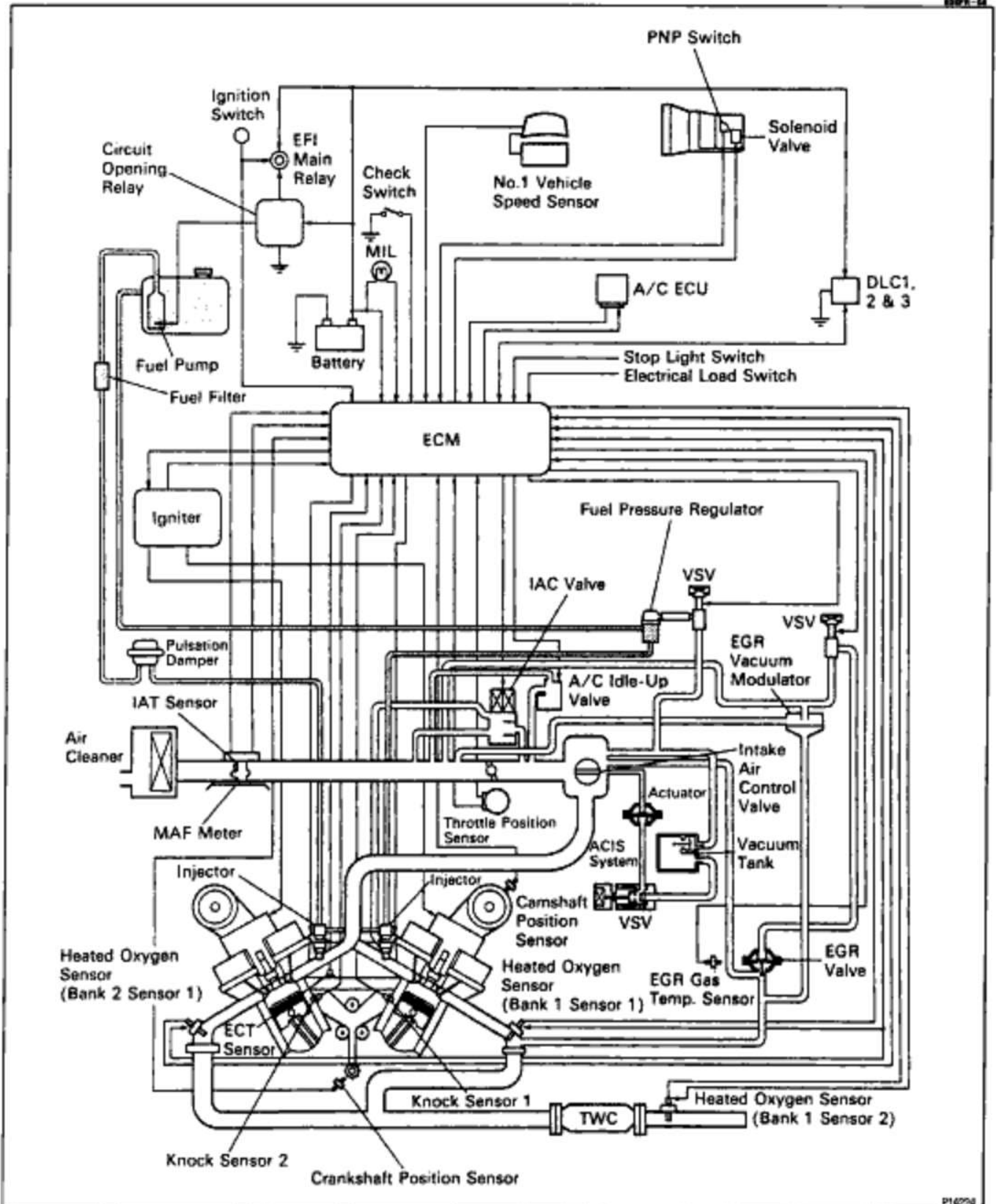

EG2-218**1MZ-FE ENGINE – SFI SYSTEM**

The SFI (Sequential Multiport Fuel Injection) system is composed of 3 basic sub-systems: Fuel, Air Induction and Electronic Control Systems.

FUEL SYSTEM

Fuel is supplied under constant pressure to the SFI injectors by an electric fuel pump. The injectors inject a metered quantity of fuel into the intake manifold in accordance with signals from the ECM (Engine Control Module).

AIR INDUCTION SYSTEM

The air induction system provides sufficient air for engine operation.

ELECTRONIC CONTROL SYSTEM

The 1 MZ-FE engine is equipped with a TOYOTA Computer Controlled System (TCCS) which centrally controls the SFI, ESA, IAC, diagnosis systems etc. by means of ECM-formerly SFI computer employing a microcomputer.

The ECM controls the following functions:

1. Sequential Multiport Fuel Injection (SFI)

The ECM receives signals from various sensors indicating changing engine operation conditions such as:

- Intake air volume
- Intake air temperature (IAT)
- Engine coolant temperature (ECT)
- Engine speed (RPM)
- Acceleration/deceleration
- Exhaust oxygen content etc.

The signals are utilized by the ECM to determine the injection duration necessary for an optimum air-fuel ratio.

2. Electronic Spark Advance (ESA)

The ECM is programmed with data for optimum ignition timing under all operating conditions. Using data provided by sensors which monitor various engine functions (RPM, ECT, etc.), the ECM triggers the spark at precisely the right instant.

3. Idle Air Control (IAC)

The ECM is programmed with target idling speed values to respond to different engine conditions (ECT, A/C (air conditioning) ON/OFF, etc.). Sensors transmit signals to the ECM which control the flow of air through the throttle valve bypass and adjust idle speed to the target value.

4. Diagnosis

The ECM detects any malfunctions and abnormalities in the sensor network and lights a malfunction indicator lamp (MIL) on the combination meter. At the same time, the trouble is identified and a diagnostic trouble code is recorded by the ECM. The diagnostic trouble codes are referred in the Engine Troubleshooting. (See page [EG2-404](#))

5. Fail-Safe Function

In the event of the sensor malfunctioning, a back-up circuit will take over to provide minimal driveability, and the malfunction indicator lamp will illuminate.

SYSTEM CIRCUIT

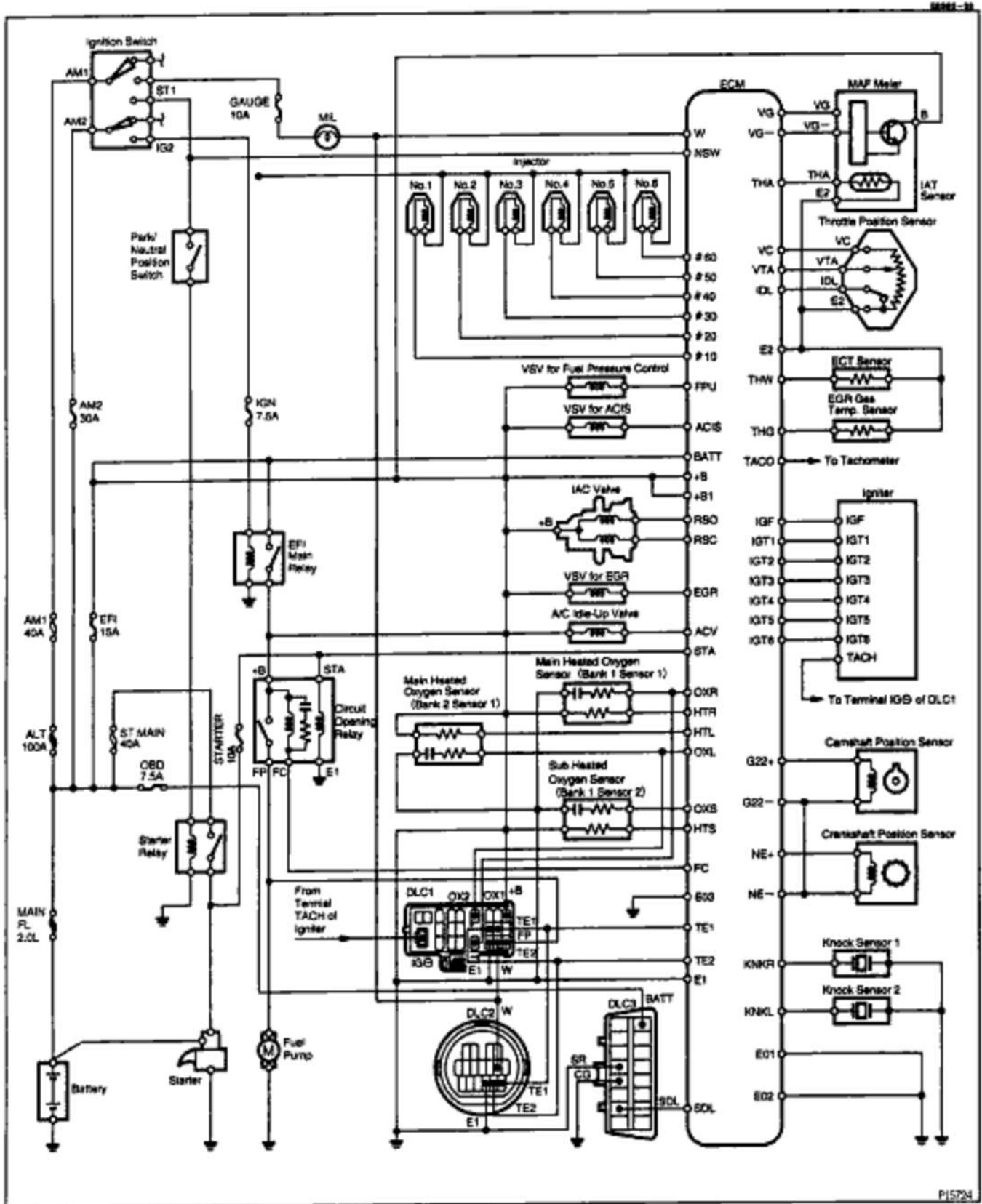

EG2-220

1MZ-FE ENGINE - SFI SYSTEM

OPERATION

FUEL SYSTEM

E80FM-06

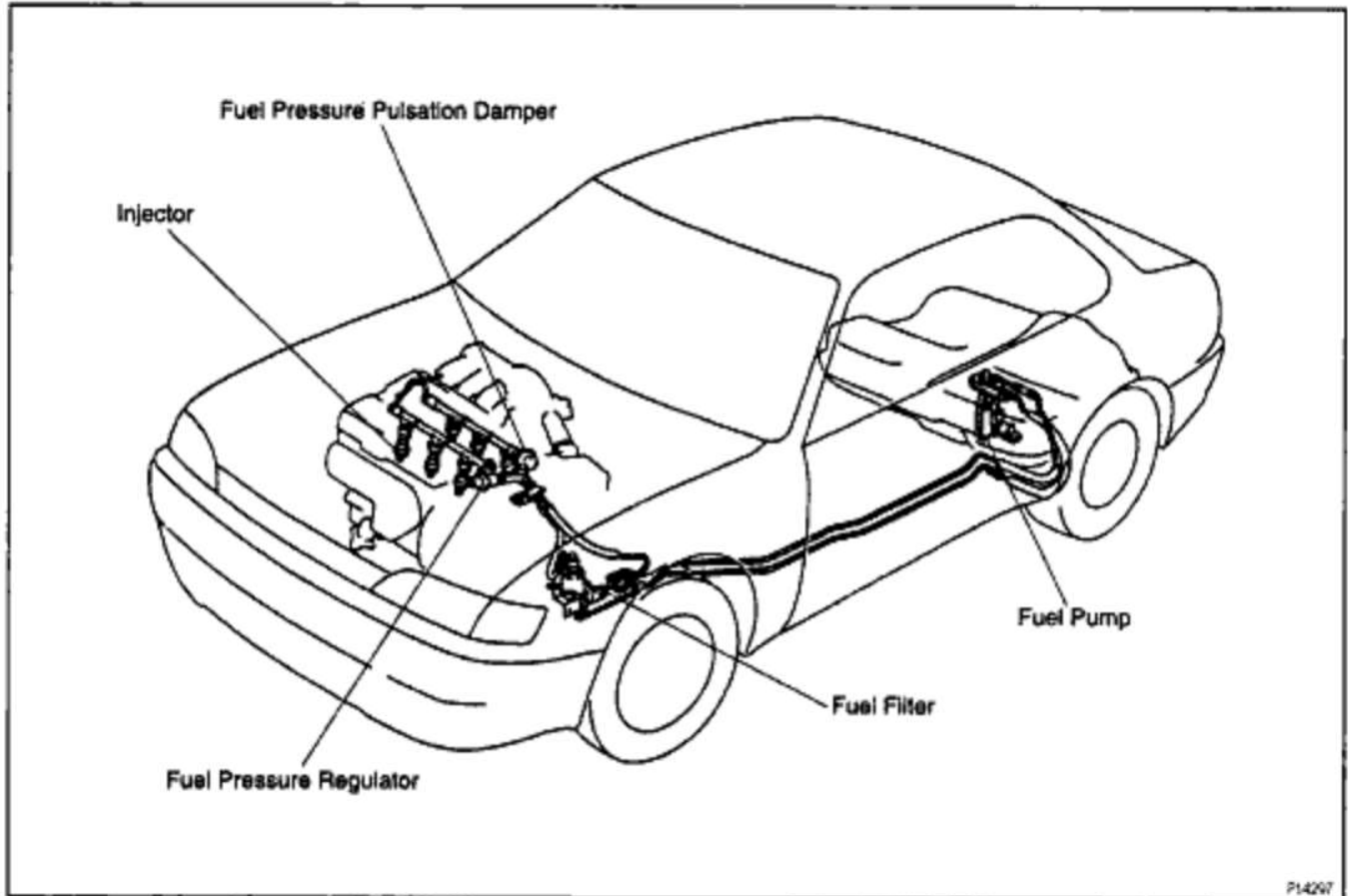

Fuel is pumped up by the fuel pump, which flows through the fuel filter under pressure through the fuel pipe to the delivery pipe where it is distributed to each injector.

The fuel pressure regulator adjusts the pressure of the fuel from the fuel line (high pressure side) to a pressure 284 kPa (2.9 kgf/cm², 41 psi) higher than the pressure inside the intake manifold, and excess fuel is returned to the fuel tank through the return tube.

When the engine is hot, the fuel pressure is increased to control percolation in the fuel system and improve restartability and idling stability.

The pulsation damper absorbs the slight fluctuations in fuel pressure caused by the injector.

Fuel is injected into the intake manifold according to signals from the ECM.

AIR INDUCTION SYSTEM

EG2-221

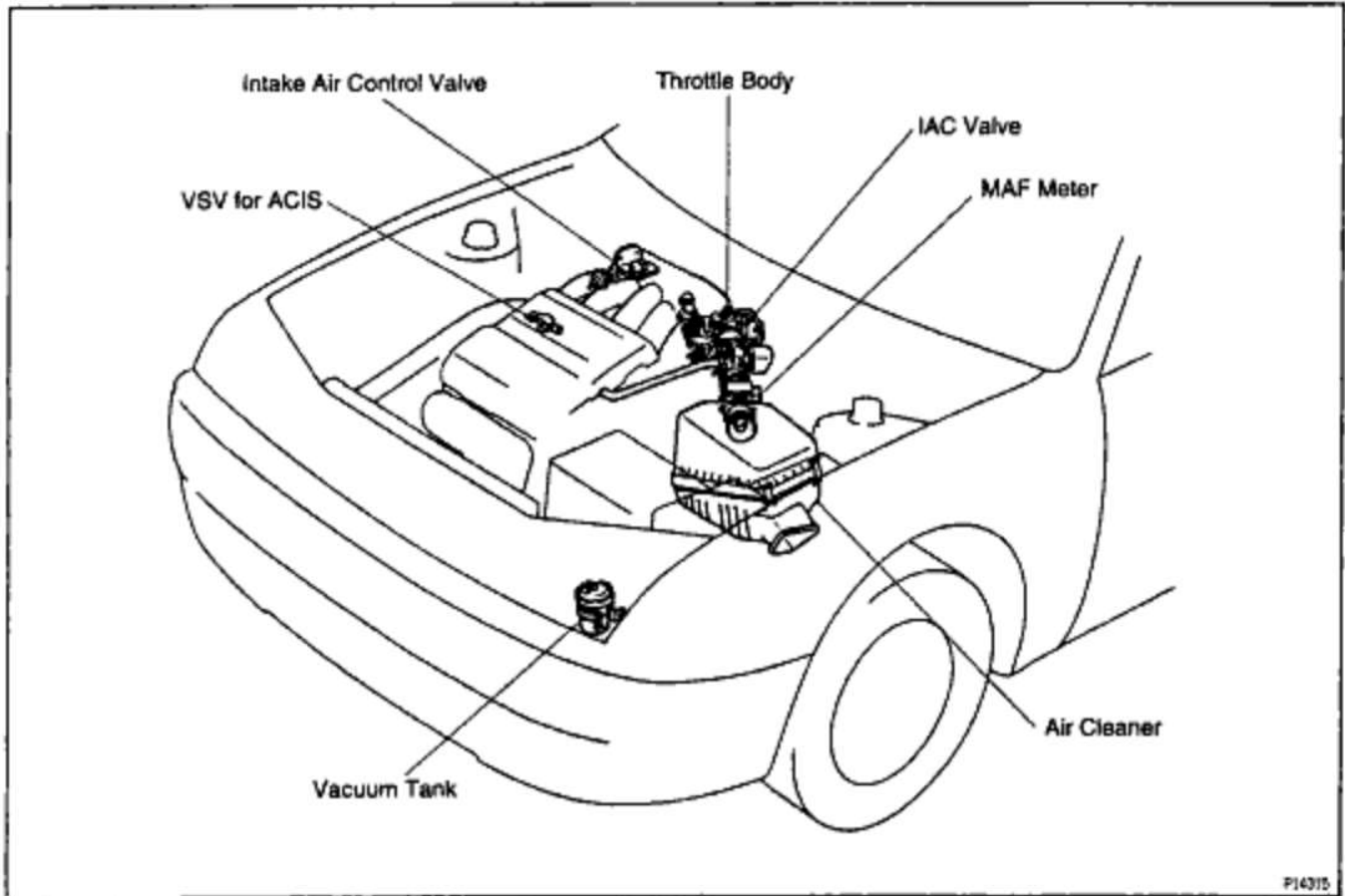

Air filtered through the air cleaner passes through the MAF meter and the amount flowing to the air intake chamber is determined by the throttle valve opening in the throttle body and the engine speed. The MAF meter measures the intake flow to the engine by measuring the air's cooling effect on the thermistor which is heated by the heater.

Located in the throttle body is the throttle valve, which regulates the volume of air intake to the engine. Air intake controlled by the throttle valve opening is distributed from the intake chamber to the manifold of each cylinder and is drawn into the combustion chamber.

At low air temperatures the IAC valve opens and the air flows through the IAC valve, as well as the throttle body, into the air intake chamber. During engine warm up, fast idle is accomplished by air flowing into the intake chamber via the IAC valve, even when the throttle valve is completely closed. In this way the IAC valve controls the idle speed to suit the operating conditions.

The air intake chamber prevents pulsation of the intake air, reduces the influence of the MAF meter and increases the air intake volume. It also prevents intake air interference in each cylinder. There is also the intake air control valve attached to the air intake chamber. Part of the ACIS, the ECM provides signals to the VSV to open or close. This valve opens or closes the vacuum source to the actuator, which in turn opens or closes the intake air control valve. The intake air control valve is designed to modify the effective manifold length in 2 stages for increased power in all driving ranges.

EG2-222

1MZ-FE ENGINE - SFI SYSTEM

ELECTRONIC CONTROL SYSTEM



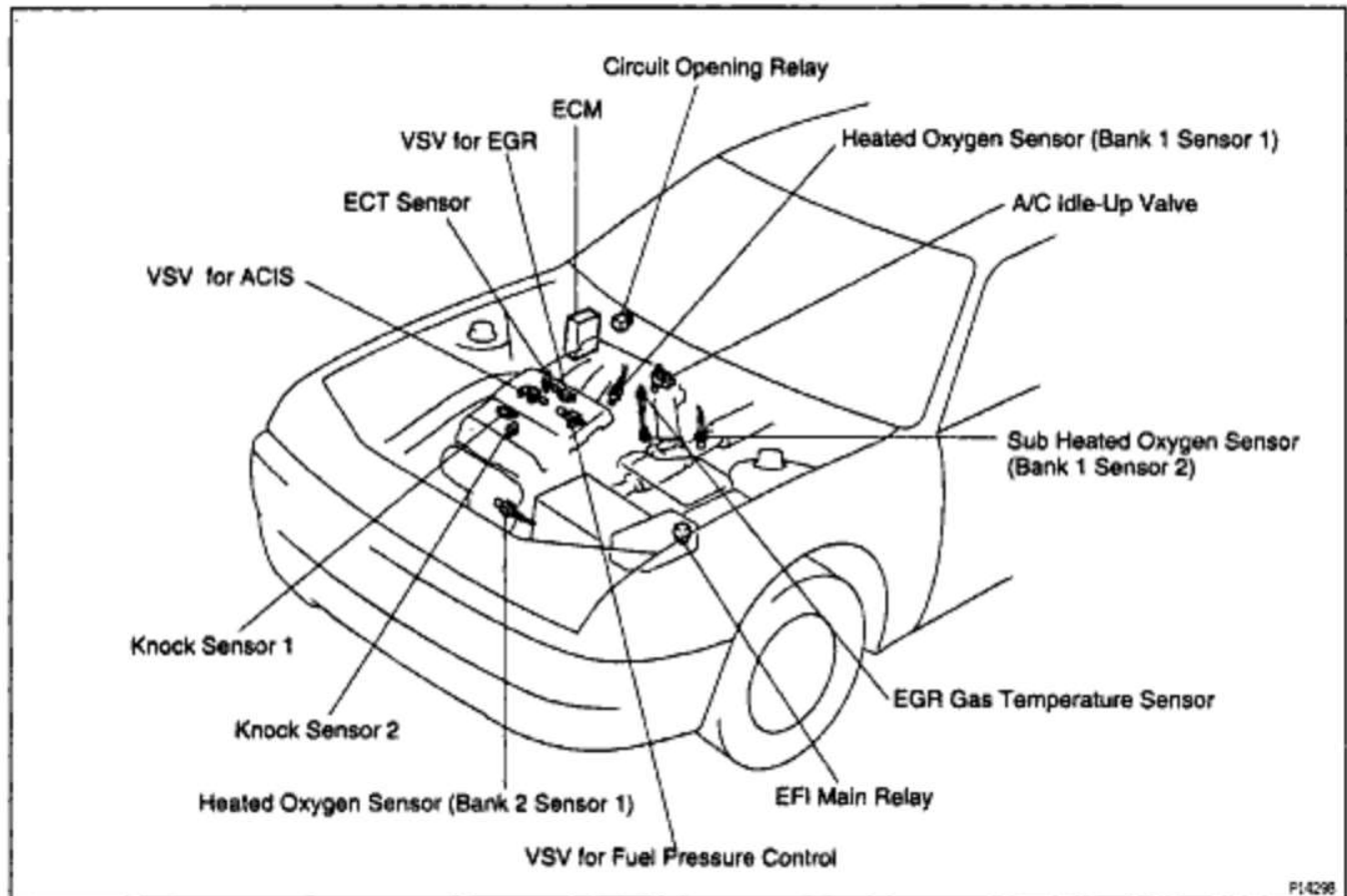





SFI-07



The control system consists of sensors which detect various engine conditions, and an ECM which determines the injection volume (timing) based on the signals from the sensors. The various sensors detect the intake air volume, engine speed, oxygen density in the exhaust gas, engine coolant temperature and intake air temperature etc. and convert the information into an electrical signal which is sent to the ECM; Based on these signals, the ECM calculates the optimum ignition timing for the current conditions and operates the injectors. The ECM not only controls the fuel injection timing, but also the self diagnostic function which records the occurrence of a malfunction, fuel volume and timing injection control, idle speed control, fuel pressure control, knock sensor control and EGR control.



PREPARATION SST (SPECIAL SERVICE TOOLS)

0902-14

	09268-41045 Injection Measuring Tool Set	
	(09268-41080) No.6 union	
	(09268-41090) No.7 Union	
	(90405-09015) No.1 Union	
	09268-45012 EFI Fuel Pressure Gauge	
	09631-22020 Power Steering Hose Nut 14 x 17 mm Wrench Set	Fuel line flare nut
	09842-30070 Wiring "F" EFI Inspection	
	09843-18020 Diagnosis Check Wire	

0906-14

RECOMMENDED TOOLS

	09082-00050 TOYOTA Electrical Tester Set	
	09200-00010 Engine Adjust Kit	
	09258-00030 Hose Plug Set	Plug for the vacuum hose, fuel hose etc.

EG2-224**1MZ-FE ENGINE - SFI SYSTEM****EQUIPMENT**

88861-01

Graduated cylinder	Injector
Carburetor cleaner	Throttle body
Sound scope	Injector
Tachometer	
Torque wrench	
Vacuum gauge	
Soft brush	Throttle body

SSM (SPECIAL SERVICE MATERIALS)

88861-01

08826-00080 Seal packing or equivalent	Intake air control valve
----------------------------------------	--------------------------

COOLANT

88861-01

Item	Capacity	Classification
Engine coolant	8.7 liters (9.2 US qts, 7.7 Imp. qts)	Ethylene-glycol base

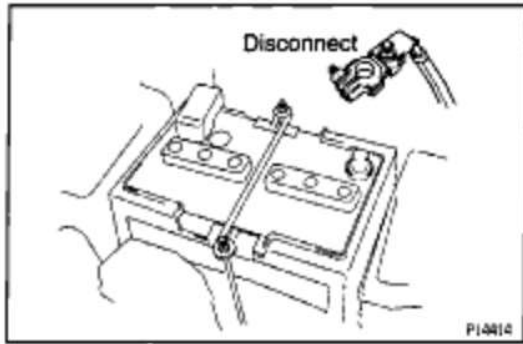

PRECAUTION

1. Before working on the fuel system, disconnect the negative (-) terminal cable from the battery.

HINT: Any diagnostic trouble code retained by the computer will be erased when the battery terminal is removed.

Therefore, if necessary, read the diagnosis before removing the battery terminal.

CAUTION: Work must be started after 90 seconds from the time the Ignition switch is turned to the "LOCK" position and the negative (-) terminal cable is disconnected from the battery.

2. Do not smoke or work near an open flame when working on the fuel system.

3. Keep gasoline away from rubber or leather parts.

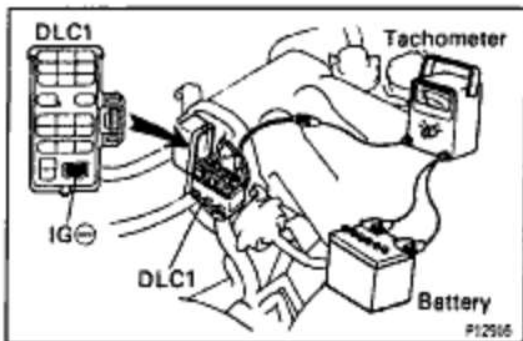

MAINTENANCE PRECAUTIONS

1. CHECK CORRECT ENGINE TUNE-UP

(See page [EG2-8](#))

2. PRECAUTIONS WHEN CONNECTING GAUGE

(a) Use the battery as the power source for the timing light, tachometer, etc.

(b) Connect the tester probe of a tachometer to the terminal IG(-) of the DLC1.

3. IN EVENT OF ENGINE MISFIRE, FOLLOWING PRECAUTIONS SHOULD BE TAKEN

(a) Check proper connection of battery terminals, etc.

(b) After repair work, check that the ignition coil terminals and all other ignition system lines are reconnected securely.

(c) When cleaning the engine compartment, be especially careful to protect the electrical system from water.

4. PRECAUTIONS WHEN HANDLING OXYGEN SENSOR

(a) Do not allow oxygen sensor to drop or hit against an object.

(b) Do not allow the sensor to come into contact with water.

IF VEHICLE IS EQUIPPED WITH MOBILE RADIO SYSTEM (HAM, CB, ETC.)

If the vehicle is equipped with a mobile communication system, refer to the precaution in the IN section.

AIR INDUCTION SYSTEM

GROUP - 02

1. Separation of the engine oil dipstick, oil filler cap, PCV hose, etc. may cause the engine to run out of tune.
2. Disconnection, looseness or cracks in the parts of the air induction system between the throttle body and cylinder head will allow air suction and cause the engine to run out of tune.

ELECTRONIC CONTROL SYSTEM

GROUP - 02

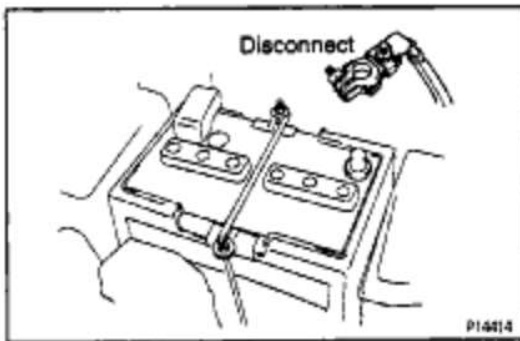

1. Before removing SFI wiring connectors, terminals, etc., first disconnect the power by either turning the ignition switch to LOCK or disconnecting the negative (-) terminal cable from the battery.
HINT: Always check the diagnostic trouble code before disconnecting the negative (-) terminal cable from the battery.
2. When installing the battery, be especially careful not to incorrectly connect the positive (+) and negative (-) cables.
3. Do not permit parts to receive a severe impact during removal or installation. Handle all SFI parts carefully, especially the ECM.
4. Do not be careless during troubleshooting as there are numerous transistor circuits and even slight terminal contact can cause further troubles.
5. Do not open the ECM cover.
6. When inspecting during rainy weather, take care to prevent entry of water. Also, when washing the engine compartment, prevent water from getting on the SFI parts and wiring connectors.
7. Parts should be replaced as an assembly.

1MZ-FE ENGINE - SFI SYSTEM

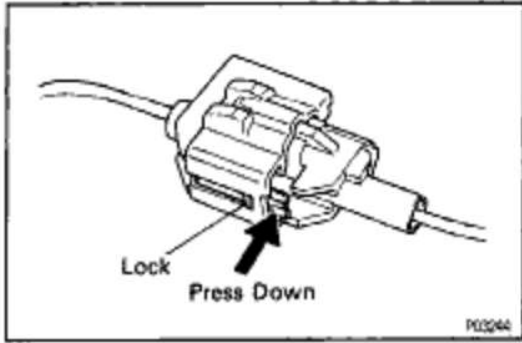

8. Care is required when pulling out and inserting wiring connectors.
 (a) Release the lock and pull out the connector, pulling on the connectors.

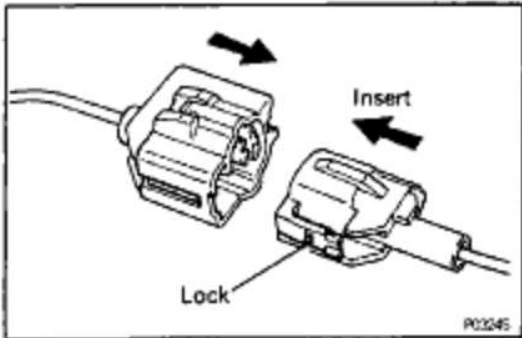

(b) Fully insert the connector and check that it is locked.

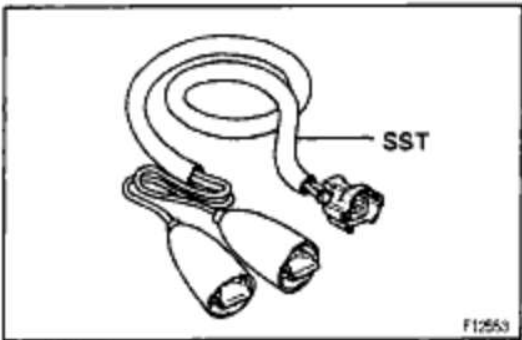

9. Use SST for inspection or test of the injector or its wiring connector.
 SST 09842-30070

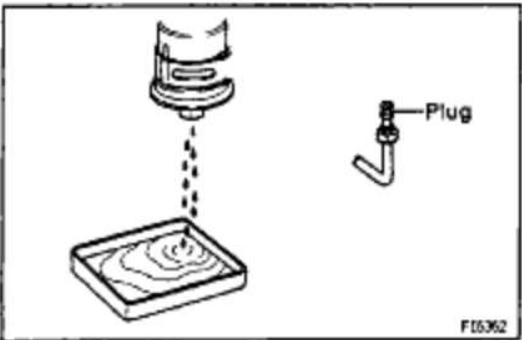

FUEL SYSTEM

1. When disconnecting the high fuel pressure line, a large amount of gasoline will spill out, so observe the following procedures:

- (a) Put a container under the connection.
- (b) Slowly loosen the connection.
- (c) Disconnect the connection.
- (d) Plug the connection with a rubber plug.

2. When connecting the flare nut or union bolt on the high pressure pipe union, observe the following procedures:

Union Bolt Type:

- (a) Always use 2 new gaskets.
- (b) Tighten the union bolt by hand.
- (c) Tighten the union bolt to the specified torque.

Torque: 30 N-m (310 kgf-cm, 22 ft-lbf)

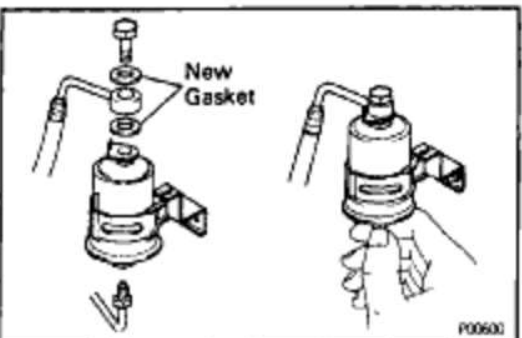

EG2-228

1MZ-FE ENGINE - SFI SYSTEM

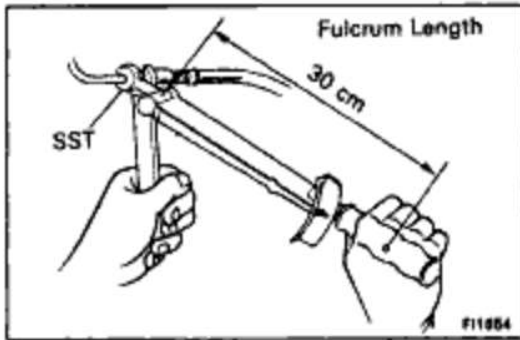

Flare Nut Type:

(a) Apply a light coat of engine oil to the flare nut, and tighten the flare nut by hand.

M Using SST, tighten the flare nut to specified torque.

SST 09631-22020

NOTICE: Do not rotate the fuel pipe, when tightening the flare nut.

Torque:

28 N-m (285 kgf-cm, 21 ft-lbf) for fuel pump side

30 N-m (310 kgf-cm, 22 ft-lbf) for others

HINT: Use a torque wrench with a fulcrum length of 30 cm (111.81 in.).

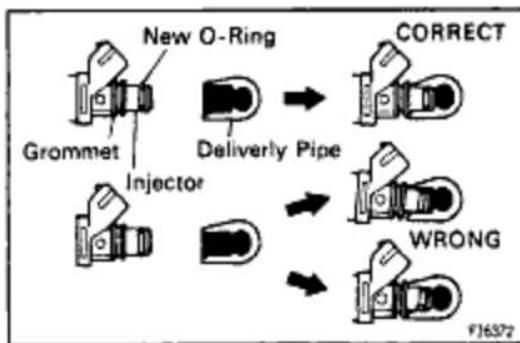

3. Observe the following precautions when removing and installing the injectors.

(a) Never reuse the O-ring.

(b) When placing a new O-ring on the injector, take care not to damage it in any way.

(c) Coat a new O-ring with spindle oil or gasoline before installing— never use engine, gear or brake oil.

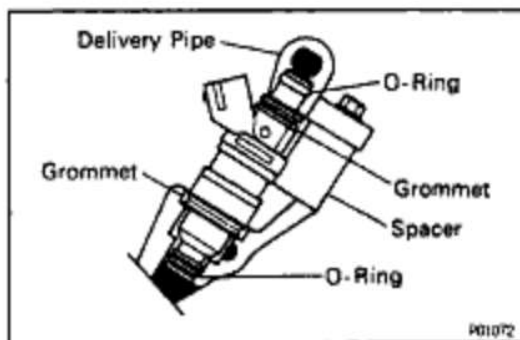

4. Install the injector to the delivery pipe and intake manifold as shown in the illustration.

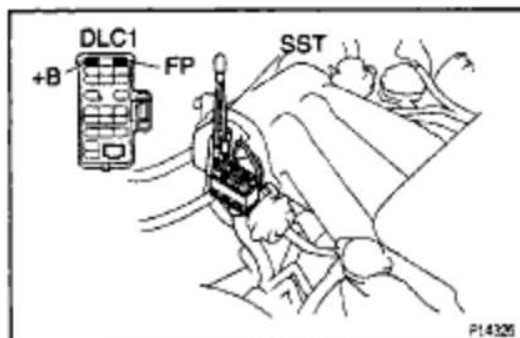

5. Check that there are no fuel leaks after performing any maintenance on the fuel system.

(a) Using SST, connect terminals +B and FP of the DLC 1.

SST 09843-18020

1MZ-FE ENGINE - SFI SYSTEM

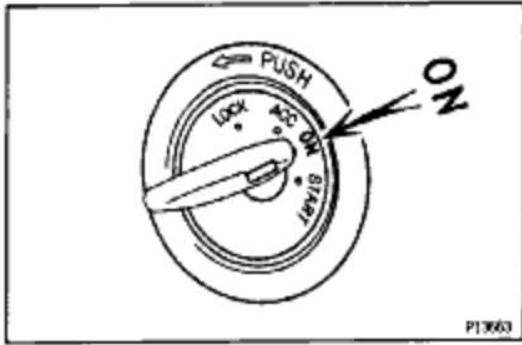

(b) With engine stopped, turn the ignition switch ON.

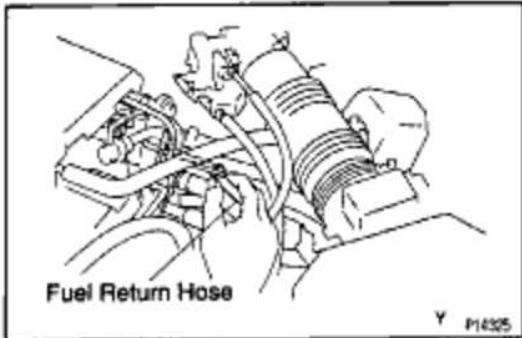

(c) Pinch the fuel return hose.

The pressure in the high pressure line will rise to approx. 392 kPa (4 kgf/cm² 57 psi). In this state, check to see that there are no leaks from any part of the fuel system.

NOTICE: Always pinch the hose. Avoid bending as it may cause the hose to crack.

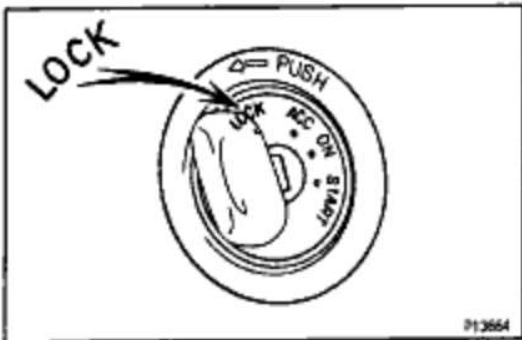

(d) Turn the ignition switch to LOCK.

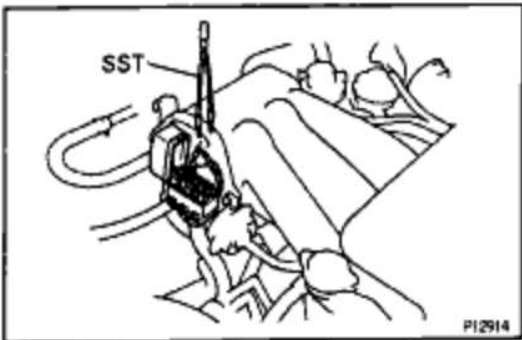

(e) Remove the SST from the DLC1.
SST 09843-18020

EG2-230

1MZ-FE ENGINE - SFI SYSTEM

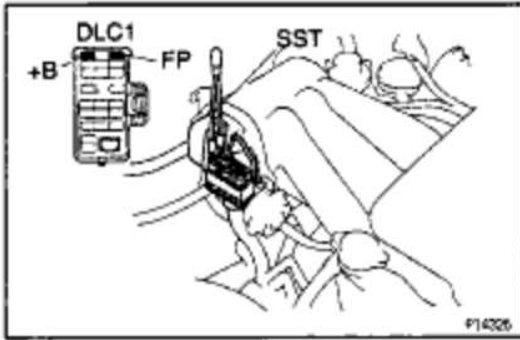

FUEL PUMP

SBN7-02

ON-VEHICLE INSPECTION

1. CHECK FUEL PUMP OPERATION

(a) Using SST, connect terminals +B and FP of the DLC

1.

SST 09843-18020

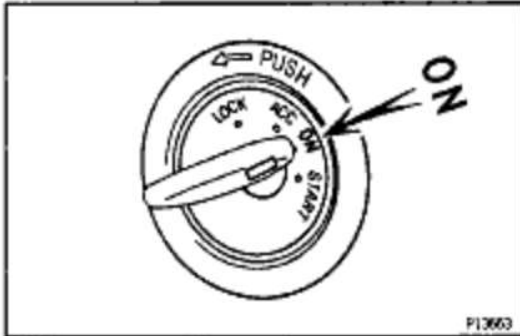

(b) Turn the ignition switch ON.

NOTICE: Do not start the engine.

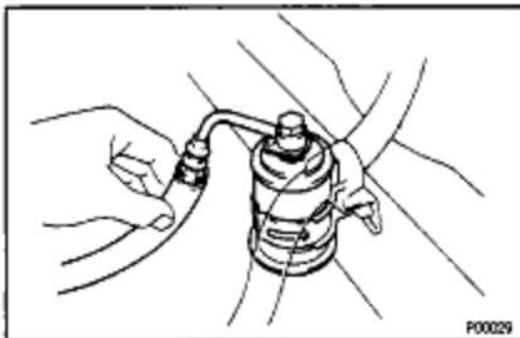

(c) Check that there is pressure in the fuel inlet hose from the fuel filter.

HINT: If there is fuel pressure, you will hear the sound of fuel flowing.

If there is no pressure, check the following parts:

- Fusible link
- Fuses (AM2 30A, IGN 7.5A)
- EFI main relay
- Fuel pump
- ECM
- Wiring connections

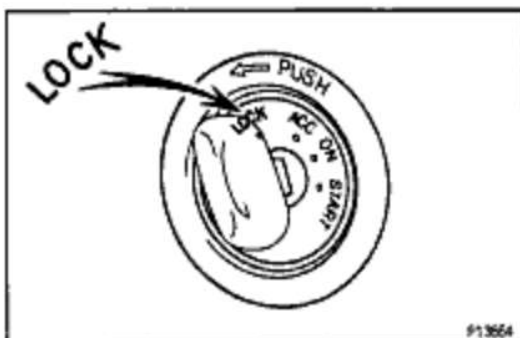

(d) Turn the ignition switch to LOCK.

1MZ-FE ENGINE - SFI SYSTEM

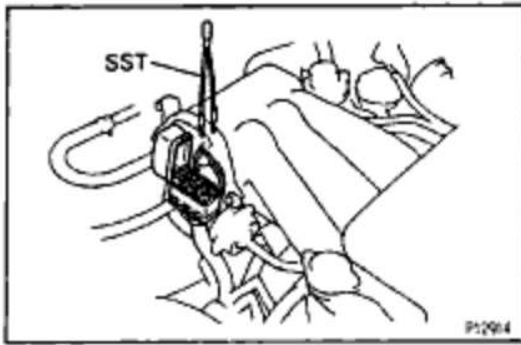

(e) Remove the SST from the DLC1.
SST 09843-18020

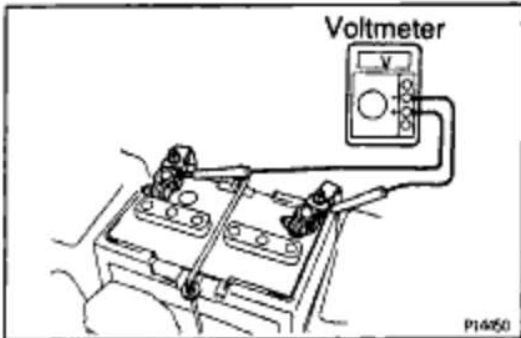

2. CHECK FUEL PRESSURE

(a) Check the battery voltage is above 12 V.

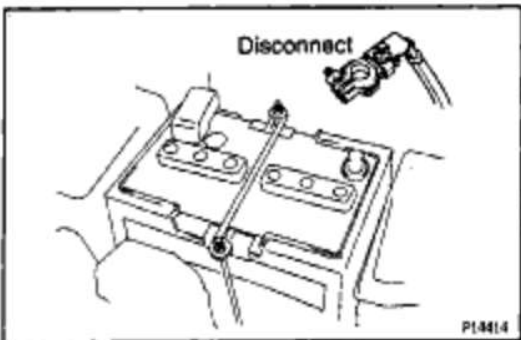

(b) Disconnect the negative (-) terminal cable from the battery.

CAUTION: Work must be started after 90 seconds from the time the ignition switch is turned to the "LOCK" position and the negative (-) terminal cable is disconnected from the battery.

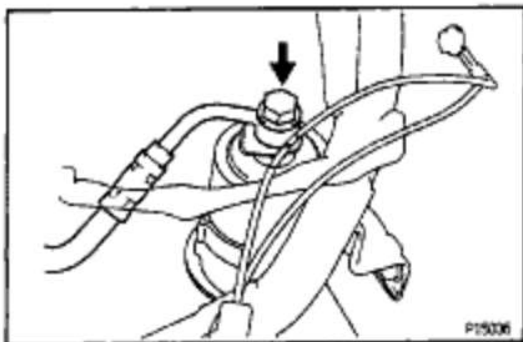

(c) Remove the union bolt and 2 gaskets, and disconnect the fuel inlet hose from the fuel filter outlet.

CAUTION:

- Put a shop towel under the fuel filter.
- Slowly loosen the union bolt.

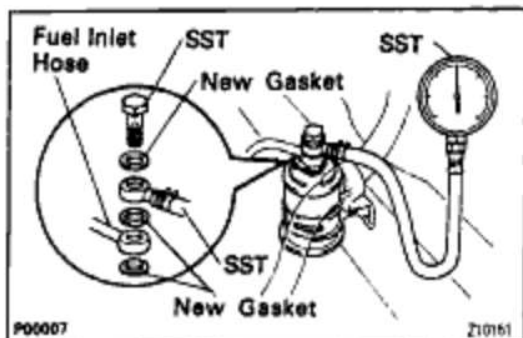

(d) Install the fuel inlet hose and SST (pressure gauge) to the fuel filter outlet with 3 new gaskets and the union bolt.

SST 09268-45012

Torque: 29 N-m (300 kgf-cm, 22 ft-lbf)

(e) Wipe off any splattered gasoline.

EG2-232

1MZ-FE ENGINE - SFI SYSTEM

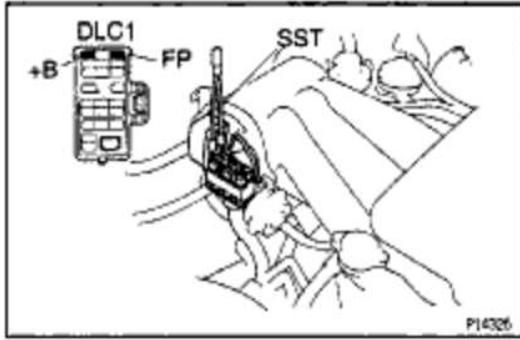

(f) Using SST, connect terminals +B and FP of the DLC 1.

(g) Reconnect the negative (-) terminal cable to the battery.

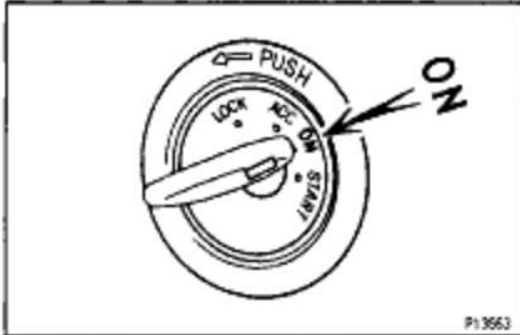

(h) Turn the ignition switch ON.

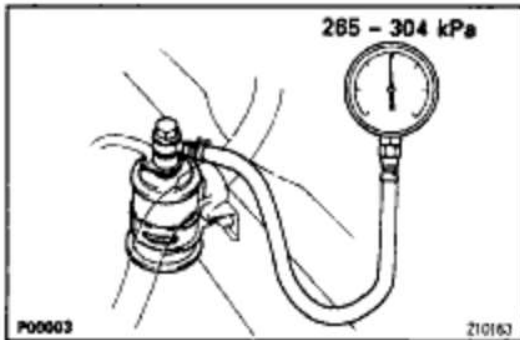

(i) Measure the fuel pressure.

Fuel pressure:

266 - 304 kPa (2.7 - 3.1 kgf/cm², 38 - 44 psi)

If pressure is high, replace the fuel pressure regulator.

If pressure is low, check the following parts:

- Fuel hoses and connections
- Fuel pump
- Fuel filter
- Fuel pressure regulator

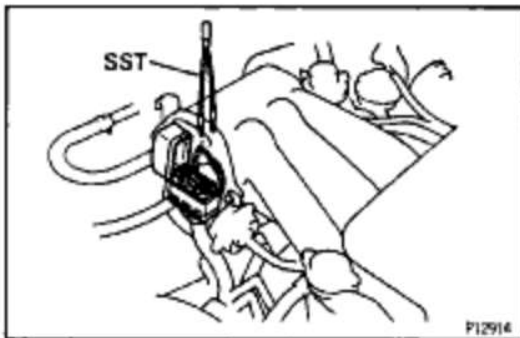

(j) Remove the SST from the DLC1.

SST 09843-18020

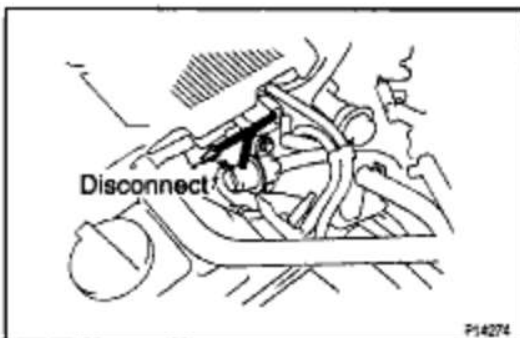

(k) Start the engine.

(l) Disconnect the vacuum sensing hose from the fuel pressure regulator, and plug the hose end.

1MZ-FE ENGINE - SFI SYSTEM

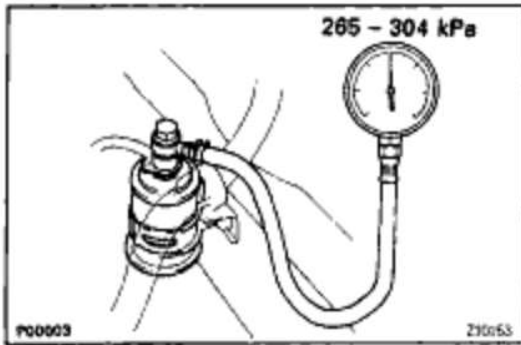

(m) Measure the fuel pressure at idle.

Fuel pressure:

265 - 304 kPa (2.7 - 3.1 kgf/cm², 39 - 44 psi)

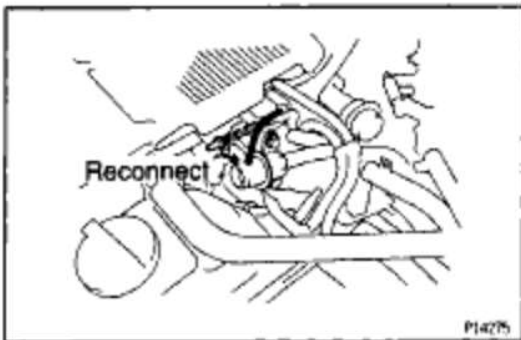

(n) Reconnect the vacuum sensing hose to the fuel pressure regulator.

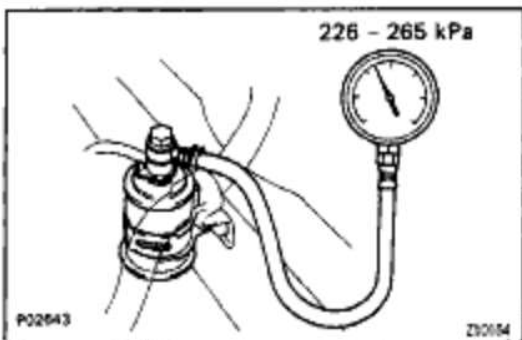

(o) Measure the fuel pressure at idle.

Fuel pressure:

226 - 265 kPa (2.3 - 2.7 kgf/cm², 33 - 38 psi)

If pressure is not as specified, check the vacuum sensing hose and fuel pressure regulator.

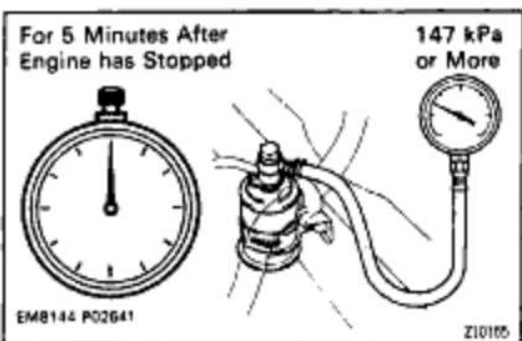

(p) Stop the engine.

(q) Check that the fuel pressure remains as specified for 5 minutes after the engine has stopped.

Fuel pressure:

147 kPa (1.5 kgf/cm², 21 psi) or more

If pressure is not as specified, check the fuel pump, pressure regulator and/or injectors.

(r) After checking fuel pressure, disconnect the negative (-) terminal cable from the battery and carefully remove the SST to prevent gasoline from splashing.
SST 09268-45012

EG2-234

1MZ-FE ENGINE - SFI SYSTEM

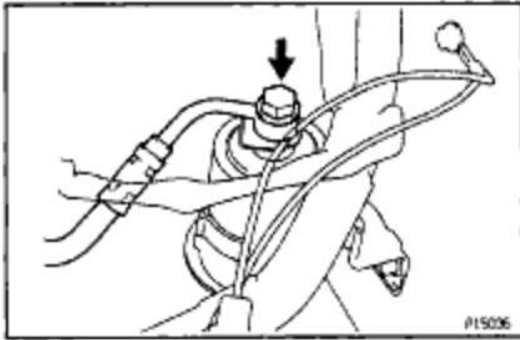

(s) Connect the fuel inlet hose with 2 new gaskets and the union bolt.

Torque: 29 N-m (300 kgf-cm, 22 ft-lbf)

(t) Reconnect the negative (-) terminal cable to the battery.

(u) Check for fuel leakage.

(See page [EG2-228](#))

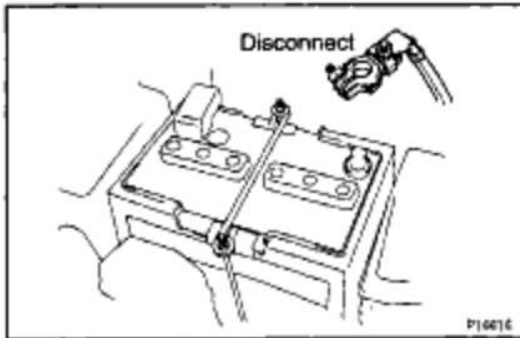

FUEL PUMP INSPECTION

1. DISCONNECT NEGATIVE (-) TERMINAL CABLE FROM BATTERY

CAUTION: Work must be started after 90 seconds from the time the ignition switch is turned to the "LOCK" position and the negative (-) terminal cable is disconnected from the battery.

2. REMOVE REAR SEAT CUSHION

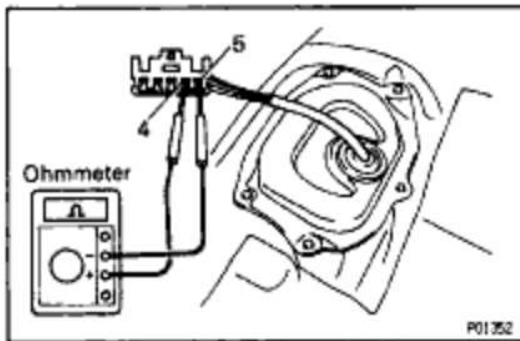

3. INSPECT FUEL PUMP

A. Inspect fuel pump resistance

Using an ohmmeter, measure the resistance between terminals 4 and 5.

Resistance:

0.2-3.0 at 20°C (88°F)

If the resistance is not as specified, replace the fuel pump.

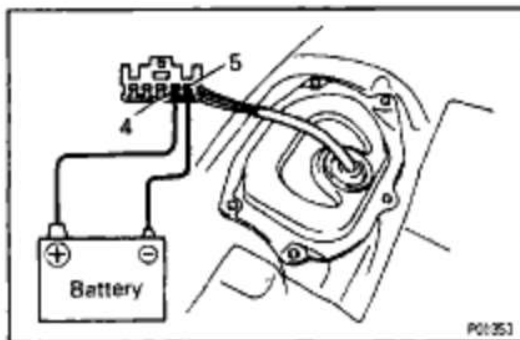

B. Inspect fuel pump operation

Connect the positive (+) lead from the battery to terminal 4 of the connector, and the negative (-) lead to terminal

5. Check that the fuel pump operates.

NOTICE:

- These tests must be performed quickly (within 10 seconds) to prevent the coil burning out.
- Keep the fuel pump as far away from the battery as possible.
- Always perform switching at the battery side.

If operation is not as specified, replace the fuel pump or lead wire.

4. REINSTALL REAR SEAT CUSHION

5. RECONNECT NEGATIVE (-) TERMINAL CABLE TO BATTERY

COMPONENTS FOR REMOVAL AND INSTALLATION

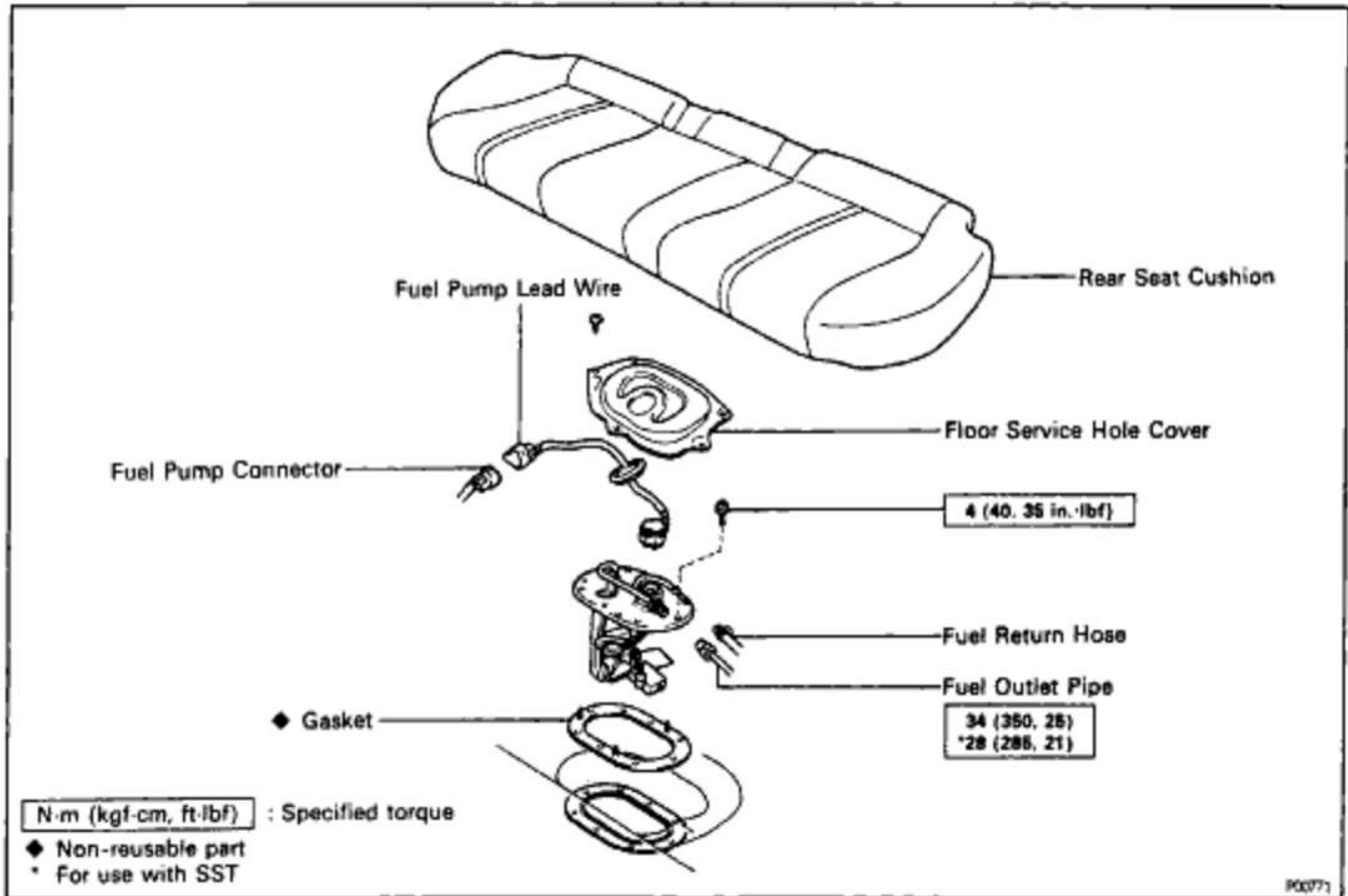

FUEL PUMP REMOVAL

(See Components for Removal and Installation)

CAUTION: Do not smoke or work near an open flame when working on the fuel pump.

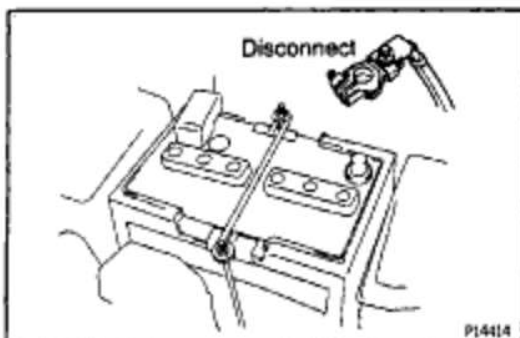

1. DISCONNECT NEGATIVE (-) TERMINAL CABLE FROM BATTERY

CAUTION: Work must be started after 90 seconds from the time the ignition switch is turned to the 'LOCK' position and the negative (-) terminal cable is disconnected from the battery.

2. REMOVE REAR SEAT CUSHION

EG2-236

1MZ-FE ENGINE - SFI SYSTEM

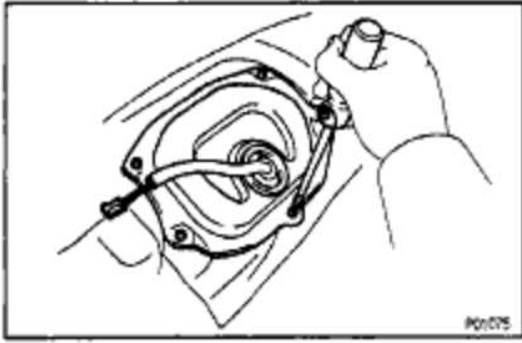
**3. REMOVE FLOOR SERVICE HOLE COVER**

- (a) Disconnect the fuel pump connector.
- (b) Remove the 5 screws and service hole cover.

4. REMOVE FUEL PUMP LEAD WIRE

NOTICE: Do not lift the fuel pump up with the wire harness picking.

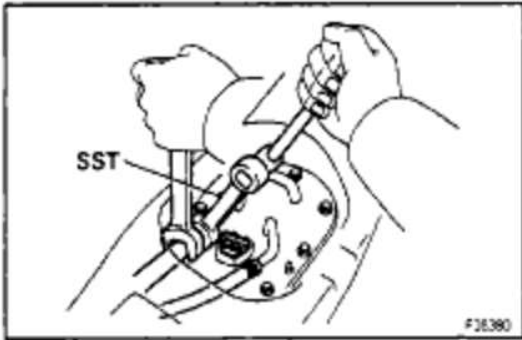
**5. DISCONNECT FUEL PIPE AND HOSE FROM FUEL PUMP BRACKET**

CAUTION: Remove the fuel filter cap to prevent the fuel from flowing out.

- (a) Using SST, disconnect the outlet pipe from the pump bracket.
- SST 09631- 22020
- (b) Disconnect the return hose from the pump bracket.

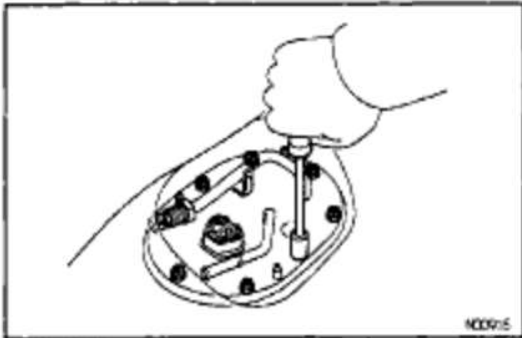
**6. REMOVE FUEL PUMP BRACKET ASSEMBLY FROM FUEL TANK**

- (a) Remove the 8 bolts.

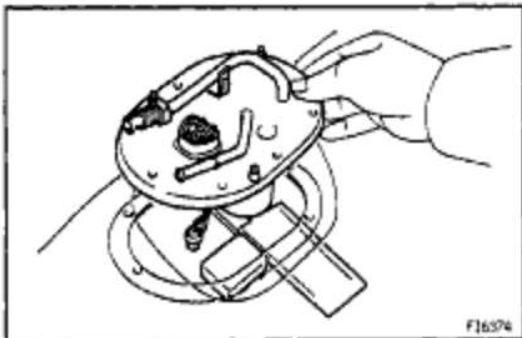

- (b) Pull out the pump bracket assembly.
- (c) Remove the gasket from the pump bracket.

COMPONENTS FOR DISASSEMBLY AND ASSEMBLY

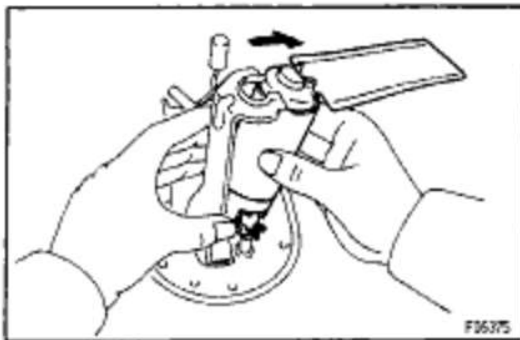
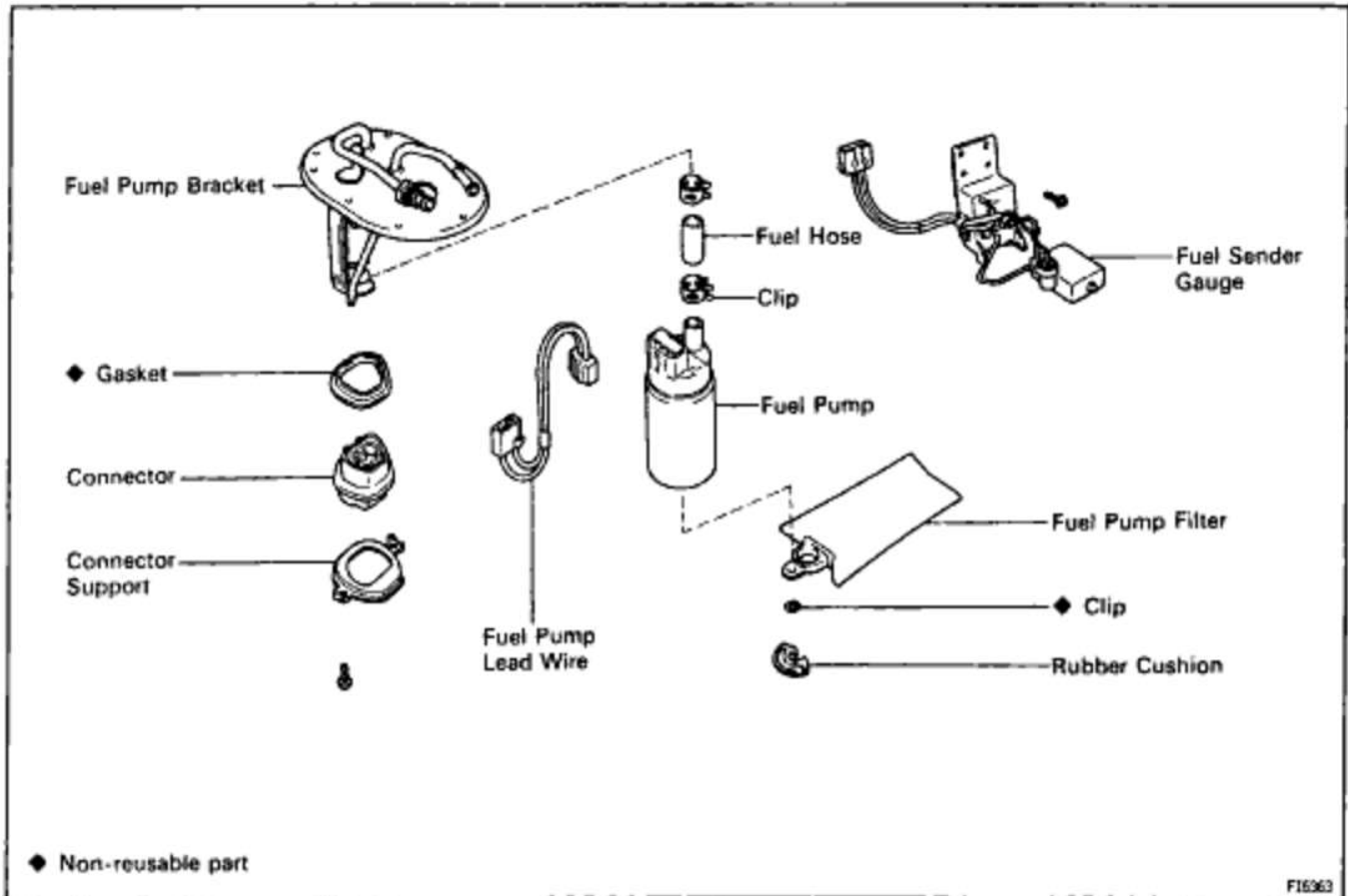

FUEL PUMP DISASSEMBLY

(See Components for Disassembly and Assembly)

1. REMOVE FUEL PUMP FROM FUEL PUMP BRACKET

- Remove the fuel pump lead wire.
- Pull off the lower side of the fuel pump from the pump bracket.
- Disconnect the fuel hose from the fuel pump, and remove the fuel pump.
- Remove the rubber cushion from the fuel pump.

2. REMOVE FUEL SENDER GAUGE FROM FUEL PUMP BRACKET

- Disconnect the fuel sender gauge connector.
- Remove the 2 screws and sender gauge.

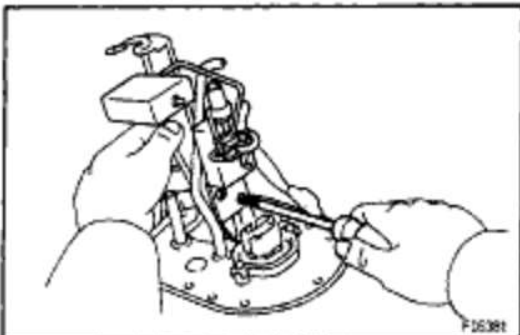

EG2-238

1MZ-FE ENGINE - SFI SYSTEM

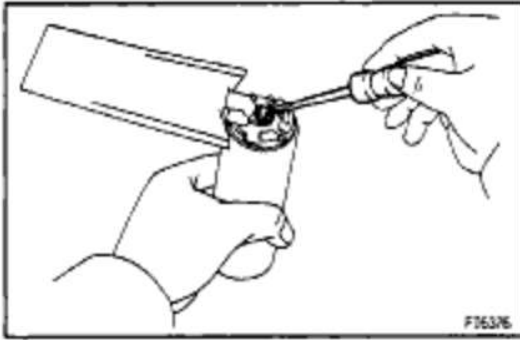
**3. REMOVE FUEL PUMP FILTER FROM FUEL PUMP**

- (a) Using a small screwdriver, remove the clip.
- (b) Pull out the pump filter.

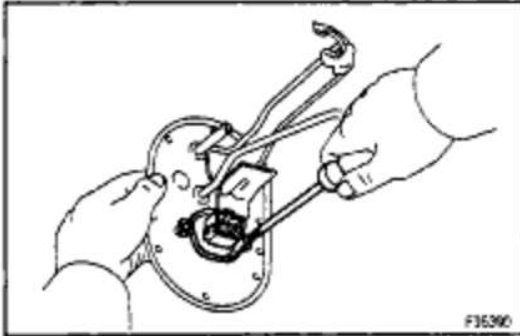
**4. REMOVE CONNECTOR**

- Remove the 2 screws, connector support, connector and gasket.

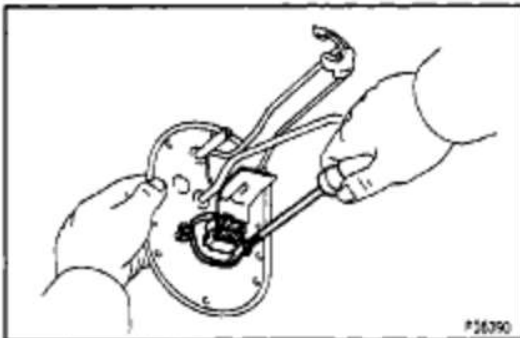
**FUEL PUMP ASSEMBLY**

(See Components for Disassembly and Assembly)

1. INSTALL CONNECTOR

- Install new gasket, the connector and connector support with the 2 screws.

2. INSTALL FUEL PUMP FILTER TO FUEL PUMP

- Install the pump filter with a new clip.

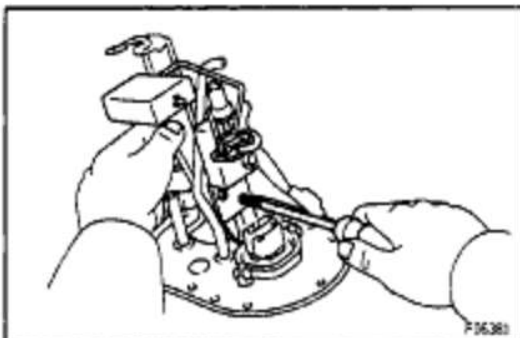
**3. INSTALL FUEL SENDER GAUGE TO FUEL PUMP BRACKET**

- (a) Install the sender gauge with the 2 screws.
- (b) Connect the fuel sender gauge connector.

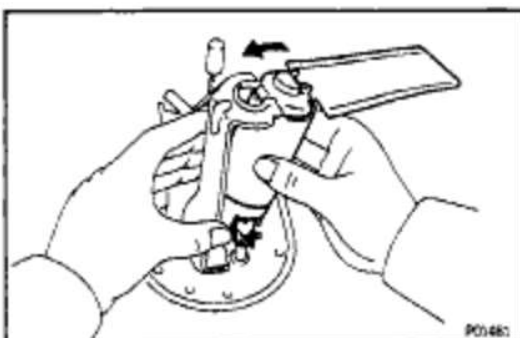
**4. INSTALL FUEL PUMP TO FUEL PUMP BRACKET**

- (a) Install the rubber cushion to the fuel pump.
- (b) Connect the fuel hose to the outlet port of the fuel pump.
- (c) Install the fuel pump by pushing the lower side of the fuel pump.
- (d) Install the fuel pump connector.

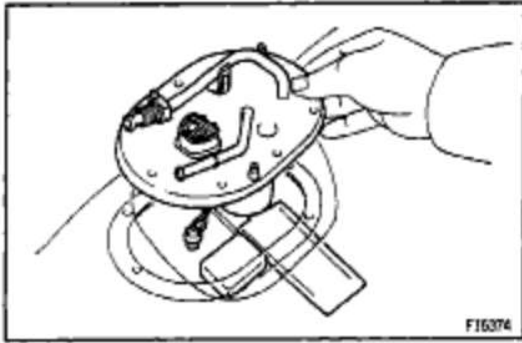

FUEL PUMP INSTALLATION

(See Components for Removal and Installation)

1. INSTALL FUEL PUMP BRACKET ASSEMBLY TO FUEL TANK

- (a) Install a new gasket to the pump bracket.
- (b) Insert the pump bracket assembly into the fuel tank.

NOTICE:

- Do not damage the fuel pump filter.
- Be careful that the arm of the sender gauge should not bent.

- (c) Install the pump bracket with the 8 screws.

Torque: 4 N-m (40 kgf-cm, 35 in.-lbf)

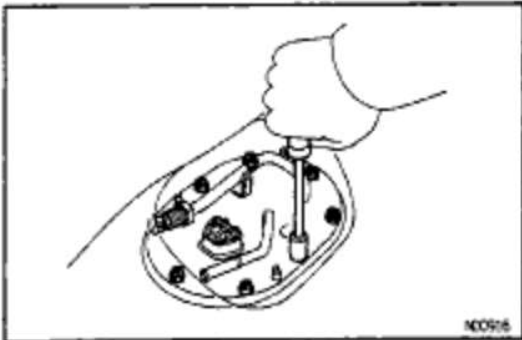

2. CONNECT FUEL PIPE AND HOSE TO FUEL PUMP BRACKET

- (a) Using SST, connect the outlet pipe to the pump bracket.

SST 09631- 22020

Torque: 28 N-m (285 kgf-cm, 21 ft-lbf) for use with SST

- (b) Connect the return hoses to the pump bracket.

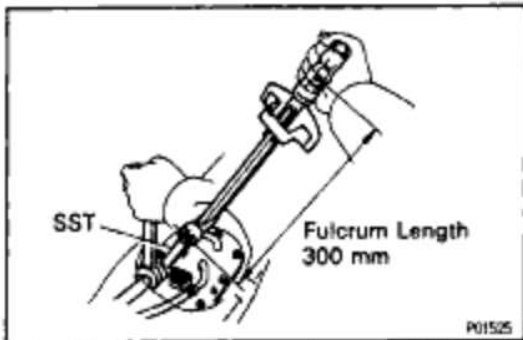

3. CONNECT FUEL PUMP LEAD WIRE

4. CONNECT NEGATIVE (-) TERMINAL CABLE TO BATTERY

6. CHECK FOR FUEL LEAKAGE

(See page [EG2-228](#))

Connect the fuel pump (with fuel sender gauge) connector.

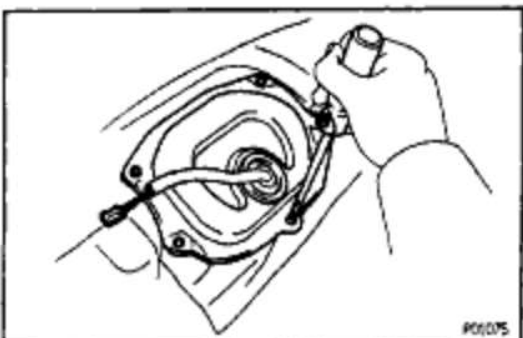

6. INSTALL FLOOR SERVICE HOLE COVER

Install the service hole cover with the 5 screws.

7. INSTALL REAR SEAT CUSHION

EG2-240

1MZ-FE ENGINE - SFI SYSTEM

FUEL PRESSURE REGULATOR

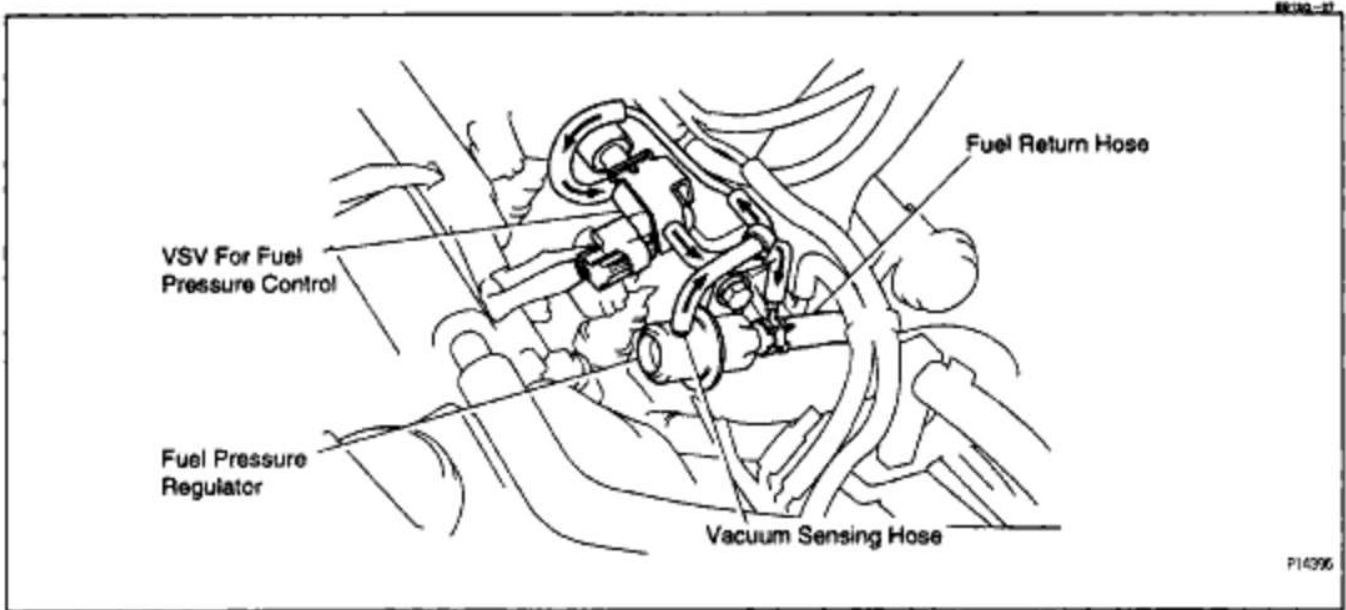

ON-VEHICLE INSPECTION

CHECK FUEL PRESSURE

(See page [EG2-231](#))

88142-08

COMPONENTS FOR REMOVAL AND INSTALLATION

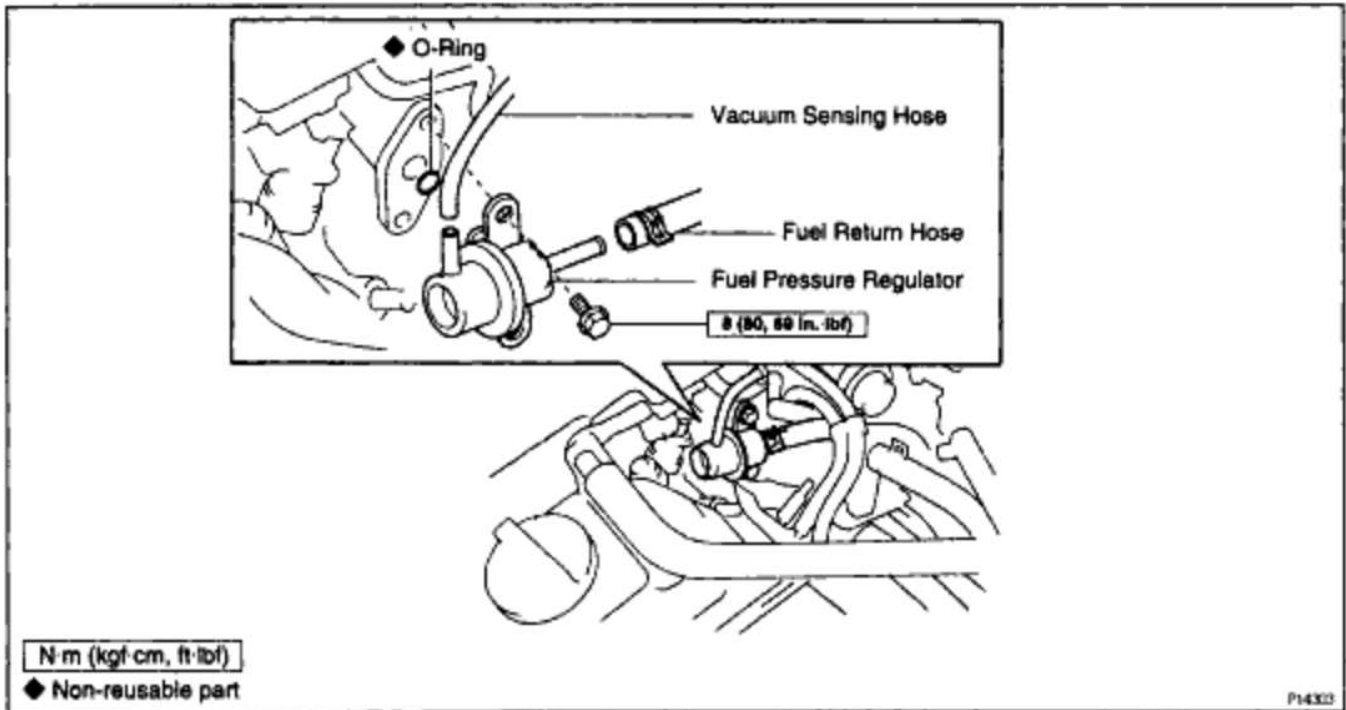

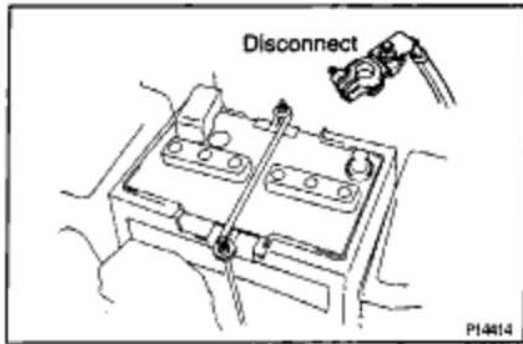

FUEL PRESSURE REGULATOR REMOVAL

(See Components for Removal and Installation)

1. DISCONNECT NEGATIVE (-) TERMINAL CABLE FROM BATTERY

CAUTION: Work must be started after 90 seconds from the time the ignition switch is turned to the 'LOCK' position and the negative (-) terminal cable is disconnected from the battery.

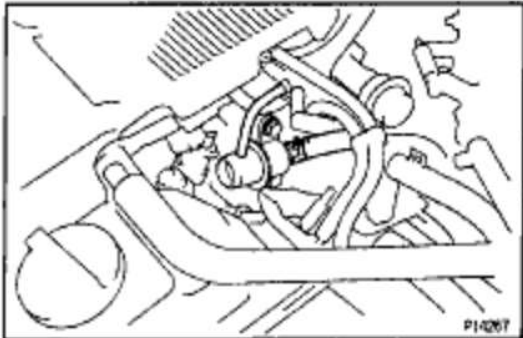

2. DISCONNECT VACUUM SENSING HOSE FROM FUEL PRESSURE REGULATOR

3. DISCONNECT FUEL RETURN HOSE FROM FUEL PRESSURE REGULATOR

CAUTION: Put a shop rag under the pressure regulator.

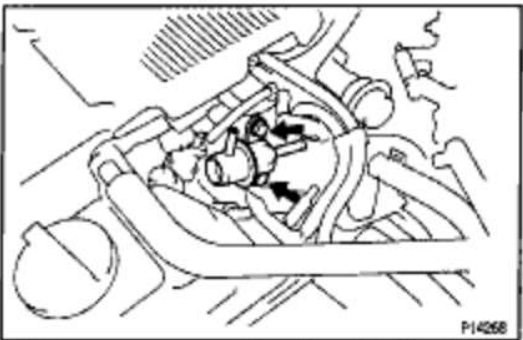

4. REMOVE FUEL PRESSURE REGULATOR

(a) Remove the 2 bolts, and pull out the pressure regulator.

(b) Remove the O-ring from the pressure regulator.

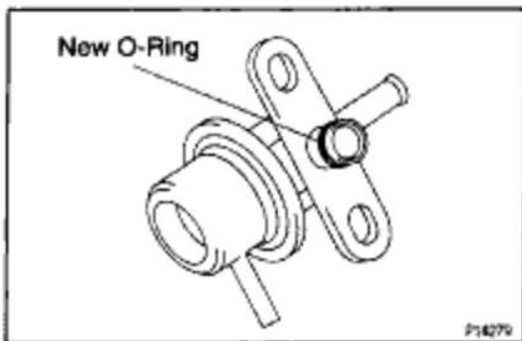

FUEL PRESSURE REGULATOR INSTALLATION

(See Components for Removal and Installation)

1. INSTALL FUEL PRESSURE REGULATOR

(a) Apply a light coat of gasoline to a new O-ring, and install it to the pressure regulator.

EG2-242

1MZ-FE ENGINE - SFI SYSTEM

(b) Attach the pressure regulator to the delivery pipe.

(c) Check that the pressure regulator rotates smoothly.

NOTICE: If it does not rotate smoothly, the O-ring may be pinched, so remove the pressure regulator and repeat steps (a) to (e) above.

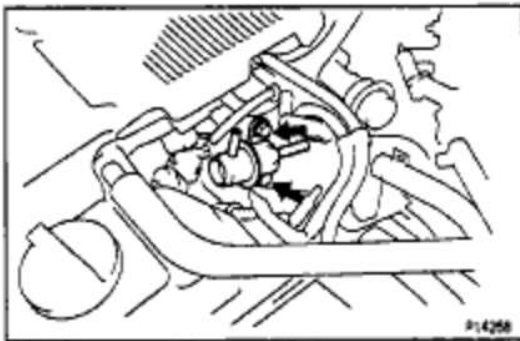
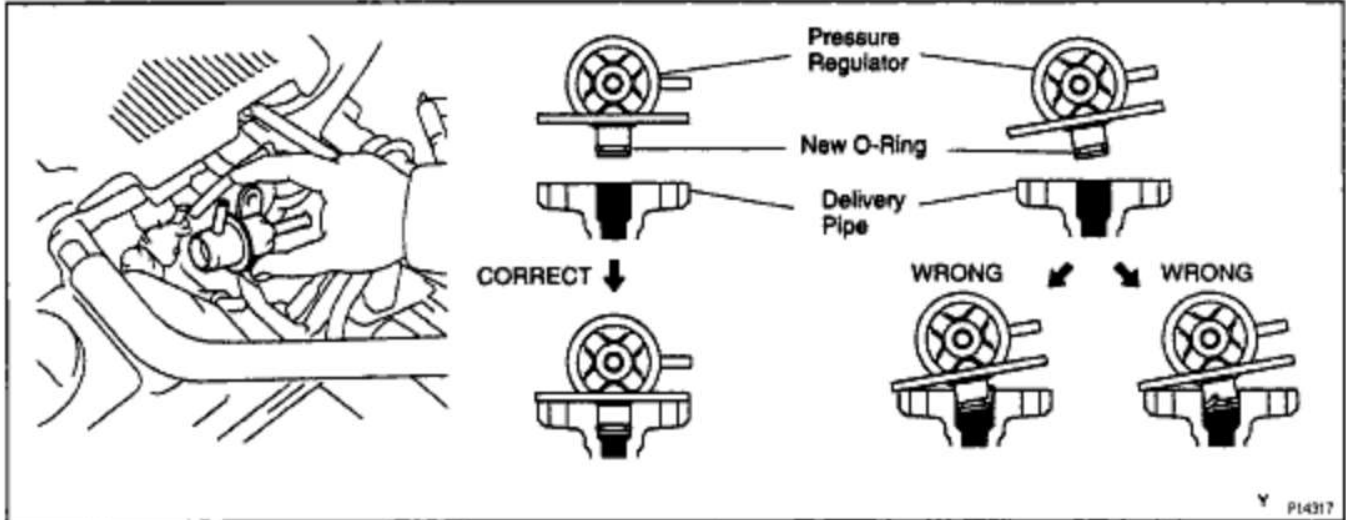

(d) Install the pressure regulator with the 2 bolts.

Torque: 8 N-m (80 kgf-cm, 69 in.-lbf)

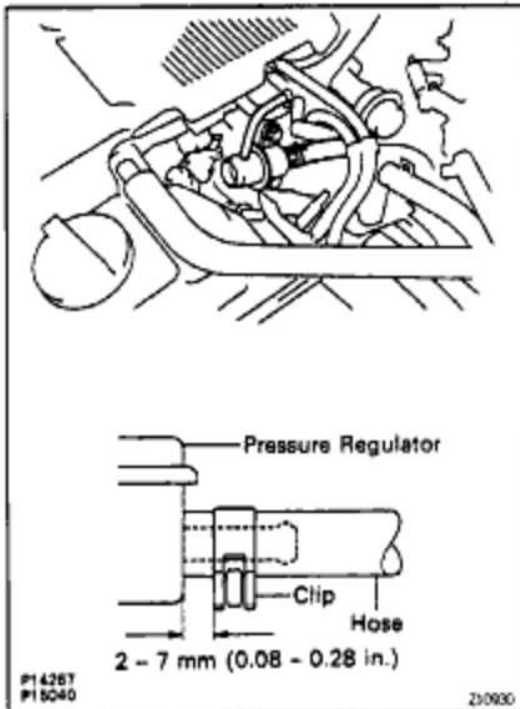

2. CONNECT FUEL RETURN HOSE TO FUEL PRESSURE REGULATOR

NOTICE: Be sure insert the hose up to the stopper and clip it.

3. CONNECT VACUUM SENSING HOSE TO FUEL PRESSURE REGULATOR

4. CONNECT NEGATIVE (-) TERMINAL CABLE TO BATTERY

5. CHECK FOR FUEL LEAKS

(See page [EC-228](#))

INJECTOR

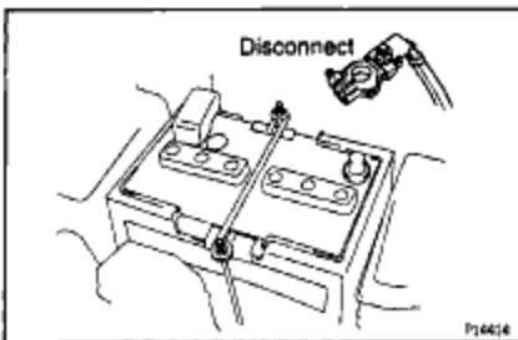
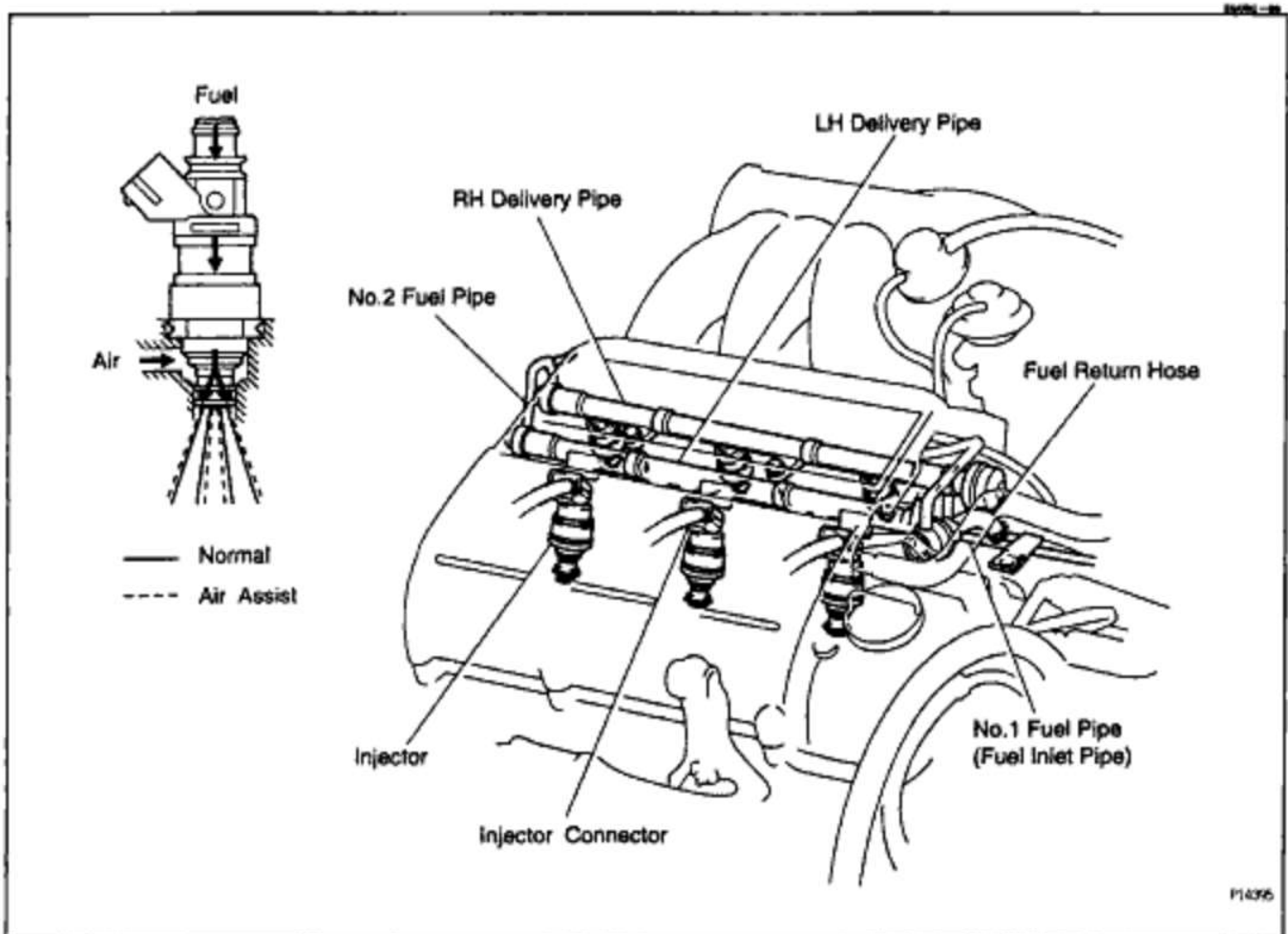

ON-VEHICLE INSPECTION

1. DISCONNECT NEGATIVE (-) TERMINAL CABLE FROM BATTERY

CAUTION: Work must be started after 90 seconds from the time the ignition switch is turned to the 'LOCK' position and the negative (-) terminal cable is disconnected from the battery.

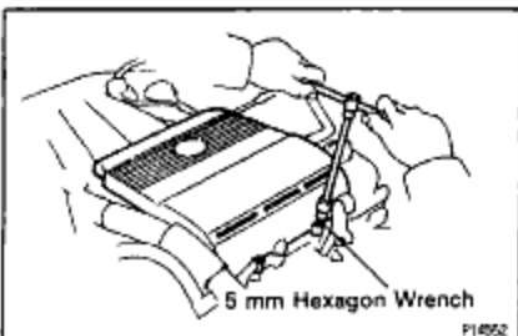

2. REMOVE V-BANK COVER

Using a 5 mm hexagon wrench, remove the 2 cap nuts and V-bank cover.

EG2-244

1MZ-FE ENGINE - SFI SYSTEM

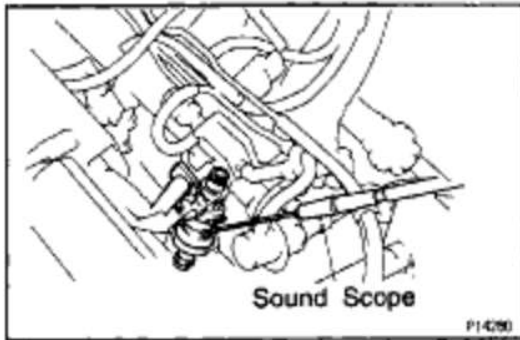
**3. INSPECT INJECTOR OPERATION**

Check operation sound from each injector.

(a) With the engine running or cranking, use a sound scope to check that there is normal operating noise in proportion to engine speed.

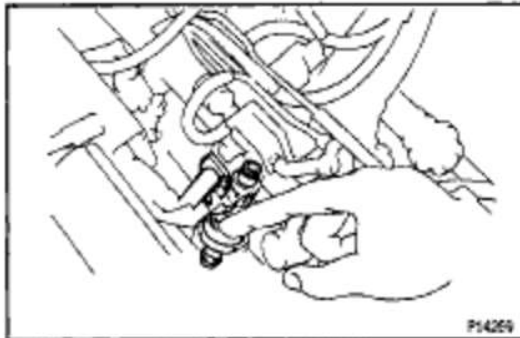

(b) If you have no sound scope, you can check the injector operating vibration with your finger. If no sound or unusual sound is heard, check the wiring connector, injector or injection signal from the ECM.

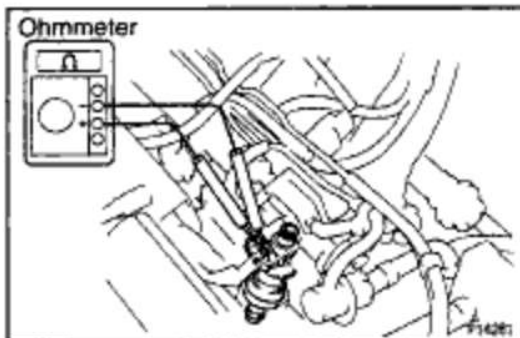
**4. INSPECT INJECTOR RESISTANCE**

(a) Disconnect the injector connector.

(b) Using an ohmmeter, measure the resistance between the terminals.

Resistance:

Approx. 13.8 at 20° C (68° F)

If the resistance is not as specified, replace the injector.

(c) Reconnect the injector connector.

5. REINSTALL V-BANK COVER

Using a 5 mm hexagon wrench, install the V-bank cover with the 2 cap nuts.

HINT: For fixing the V-bank cover, push on the cover until sense of "click" is felt.

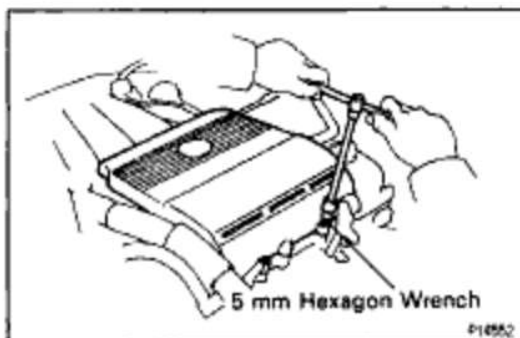
**6. RECONNECT NEGATIVE (-) TERMINAL CABLE TO BATTERY**

EG2-246

1MZ-FE ENGINE - SFI SYSTEM

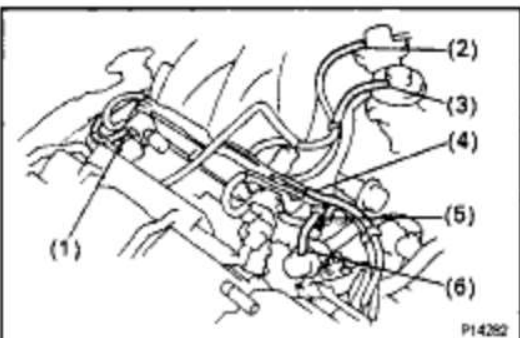
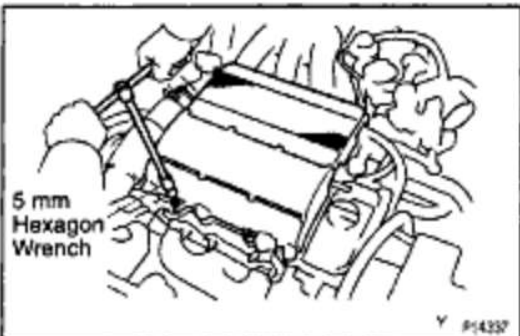
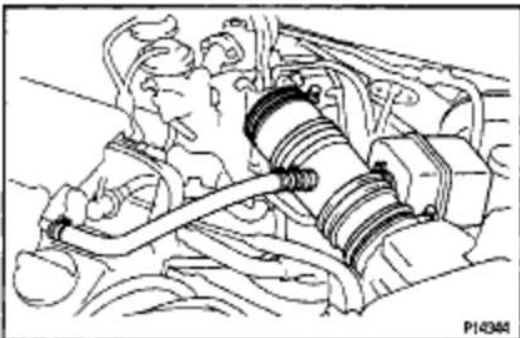
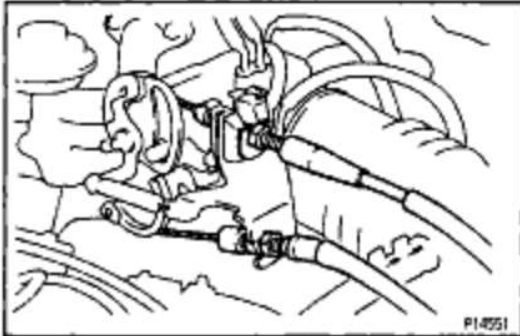
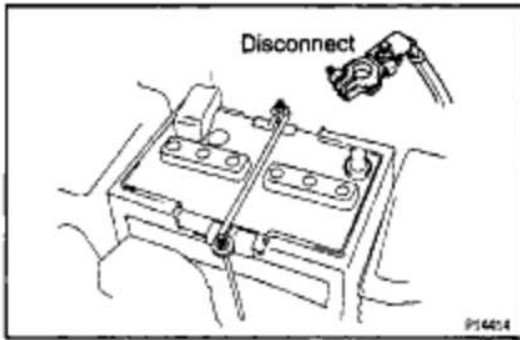
**INJECTORS REMOVAL**

(See Components for Removal and Installation)

1. DISCONNECT NEGATIVE (-) TERMINAL CABLE FROM BATTERY

CAUTION: Work must be started after 90 seconds from the time the Ignition switch is turned to the 'LOCK' position and the negative (-) terminal cable is disconnected from the battery.

2. DRAIN ENGINE COOLANT**3. DISCONNECT ACCELERATOR CABLE****4. DISCONNECT THROTTLE CABLE****6. REMOVE AIR CLEANER HOSE**

(a) Disconnect the PCV hose.

(b) Loosen the 2 hose clamps, and remove the air cleaner hose.

6. REMOVE V-SANK COVER

Using a 5 mm hexagon wrench, remove the 2 cap nuts and v-bank cover.

7. REMOVE EMISSION CONTROL VALVE SET

(a) Disconnect the following vacuum hoses:

- (1) Vacuum hose from VSV for ACIS
- (2) Vacuum hose from EGR vacuum modulator
- (3) Vacuum hose from EGR valve
- (4) Vacuum hose (from cylinder head rear plate)
- (5) Vacuum hose from air intake chamber
- (6) Vacuum hose from fuel pressure regulator

1MZ-FE ENGINE - SFI SYSTEM

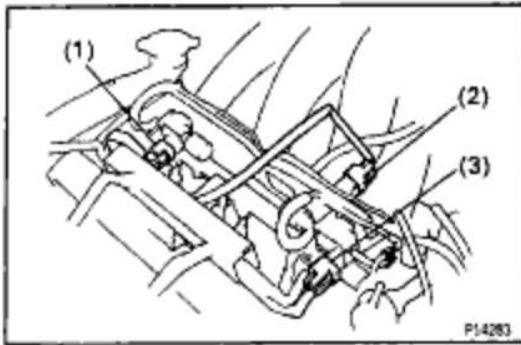

- (b) Disconnect the following connectors:
- (1) VSV connector for ACIS
 - (2) VSV connector for EGR
 - (3) VSV connector for fuel pressure control

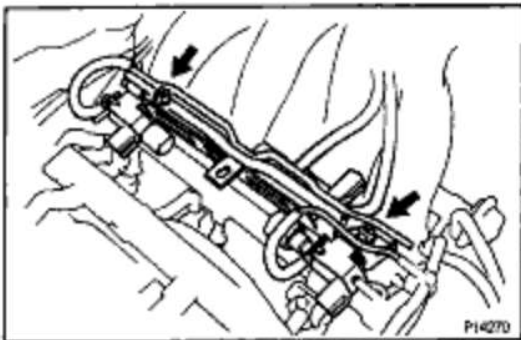

- (c) Remove the 2 nuts and emission control valve set.

**8. REMOVE No.2 EGR PIPE**

Remove the 4 nuts, EGR pipe and 2 gaskets.

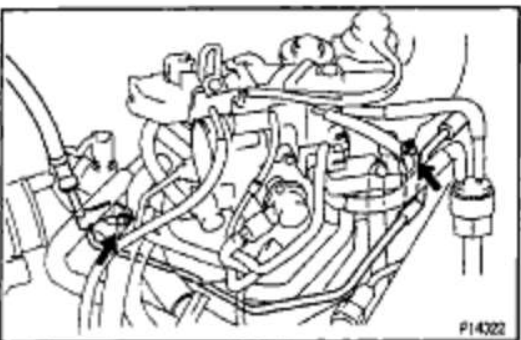
**9. DISCONNECT HYDRAULIC MOTOR PRESSURE PIPE**

Remove the 2 bolts, and disconnect the pressure pipe from the water inlet and air intake chamber.

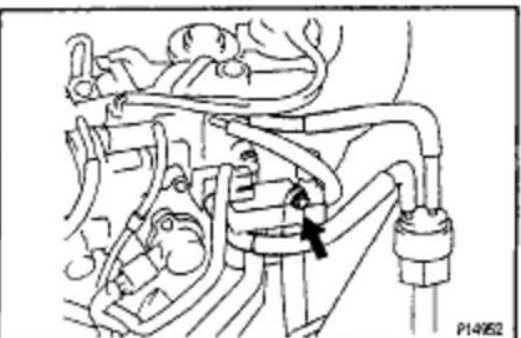
**10. REMOVE AIR INTAKE CHAMBER ASSEMBLY**

- (a) Disconnect the 2 PS air hoses.
- (b) Remove the bolt holding the air intake chamber stay to the air intake chamber.

EG2-248

1MZ-FE ENGINE - SFI SYSTEM

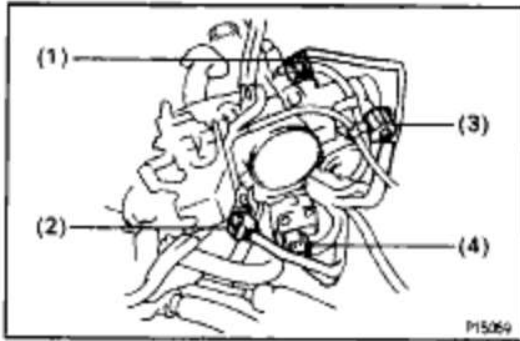

- (c) Disconnect the following connectors:
- (1) A/C idle-up valve connector
 - (2) EGR gas temperature sensor connector
 - (3) Throttle position sensor connector
 - (4) IAC valve connector

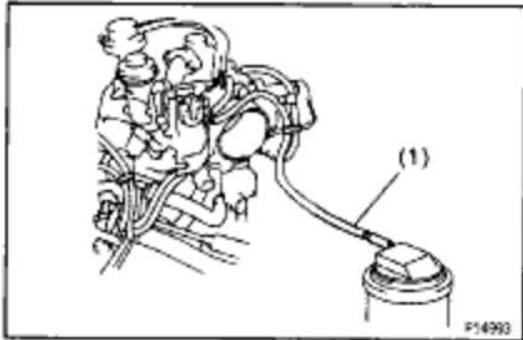

- (d) Disconnect the following vacuum hoses:
- (1) Vacuum hose from charcoal canister

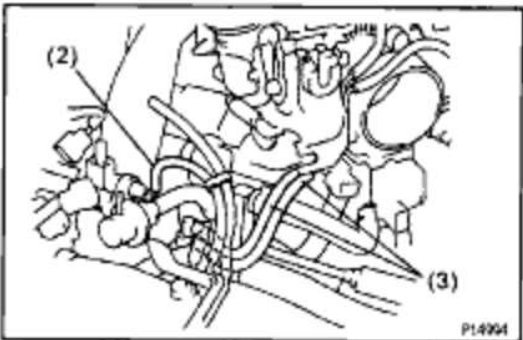

- (2) Vacuum hose from air intake chamber
- (3) 2 vacuum hoses from throttle body

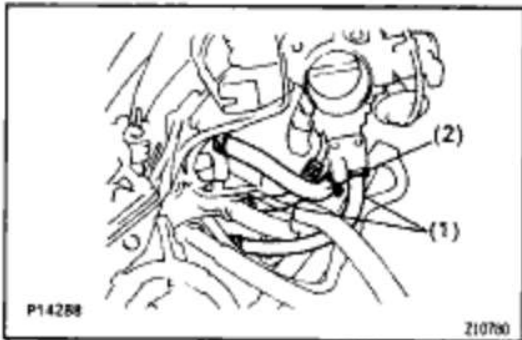

- (e) Disconnect the following hoses:
- (1) 2 water bypass hoses from throttle body
 - (2) Air assist hose from throttle body

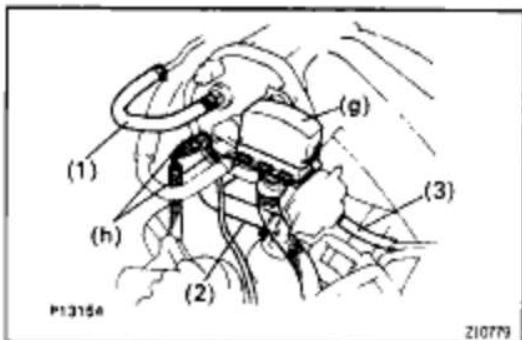

- (f) Disconnect the following hoses:
- (1) Brake booster vacuum hose
 - (2) PCV hose
 - (3) Actuator vacuum hose
- (g) Disconnect the DLC1.
- (h) Remove the nut and disconnect the 2 ground straps.

1MZ-FE ENGINE - SFI SYSTEM

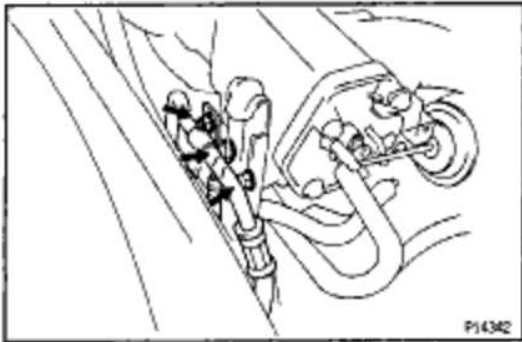

- (i) Remove the nut and disconnect the PS pressure tube.
- (j) Remove the bolt holding the No.1 engine hanger to the air intake chamber.
- (k) Remove the bolt, and disconnect the ground strap.

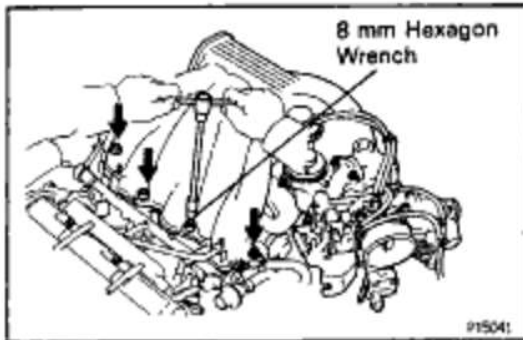

Using a 8 mm hexagon wrench, remove the 2 bolts, 2 nuts, air intake chamber assembly and gasket.

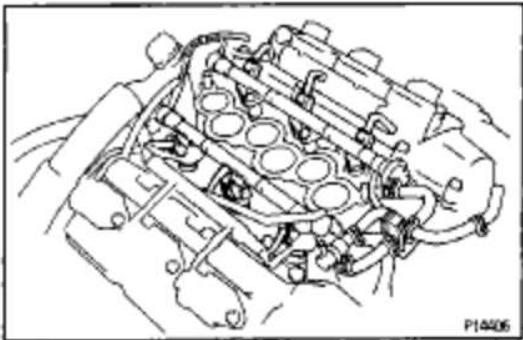
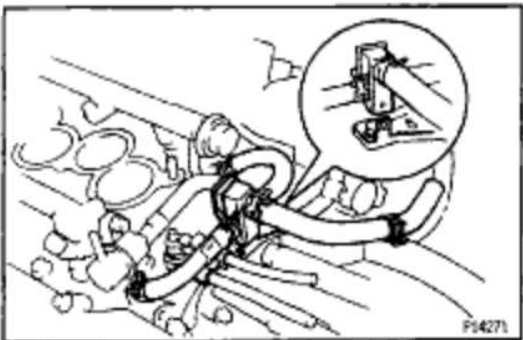
**11. DISCONNECT INJECTOR CONNECTORS****12. REMOVE AIR ASSIST HOSES AND PIPE**

- (a) Disconnect the air assist pipe from the bracket on the No.1 fuel pipe.
- (b) Remove the air assist hoses from the intake manifold.

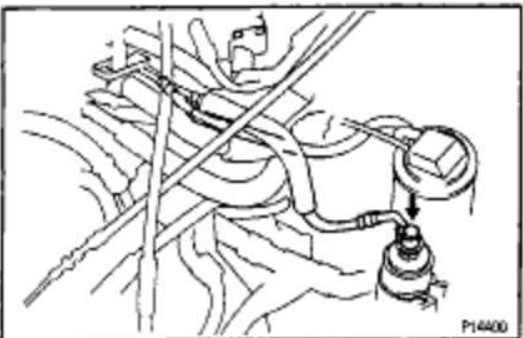
**13. DISCONNECT FUEL INLET AND RETURN HOSES**

- (a) Disconnect the fuel return hose from the No.1 fuel pipe.
 - (b) Disconnect the fuel inlet hose from the fuel filter.
- CAUTION: Catch leaking fuel in a container.**

EG2-250

1MZ-FE ENGINE - SFI SYSTEM

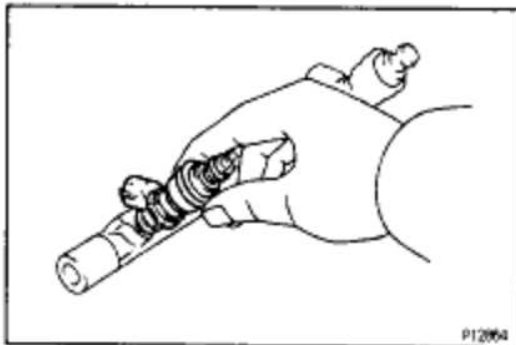
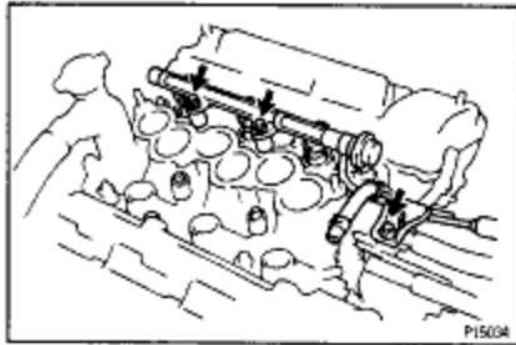
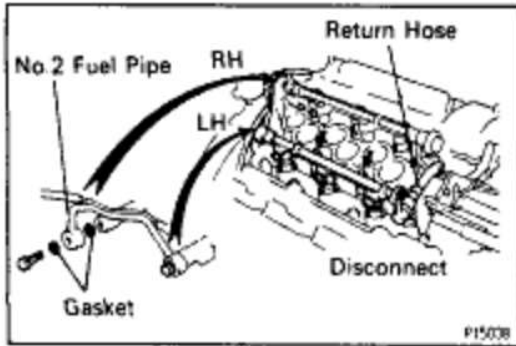
**14. REMOVE DELIVERY PIPES AND INJECTORS**

NOTICE: Be careful not to drop the injectors when removing the delivery pipes.

- (a) Loosen the 2 union bolts holding the No.2 fuel pipe to the delivery pipes.
- (b) Disconnect the fuel return hose from the fuel pressure regulator.
- (c) Remove the union bolt for the RH delivery pipe, 2 gaskets, 2 bolts, LH delivery pipe together with the 3 injectors and No.2 fuel pipe.
- (d) Remove the union bolt for the LH delivery pipe and 2 gaskets from the No.2 fuel pipe.
- (e) Remove the 3 bolts, RH delivery pipe together with the 3 injectors and No.1 fuel pipe.
- (f) Remove the 4 spacers from the intake manifold.

- (g) Pull out the 6 injectors from the delivery pipes.
- (h) Remove the 2 O-rings and 2 grommets from each injector.

INJECTORS INSPECTION

M007-91

1. INSPECT INJECTOR INJECTION

CAUTION: Keep injector clear of sparks during the test.

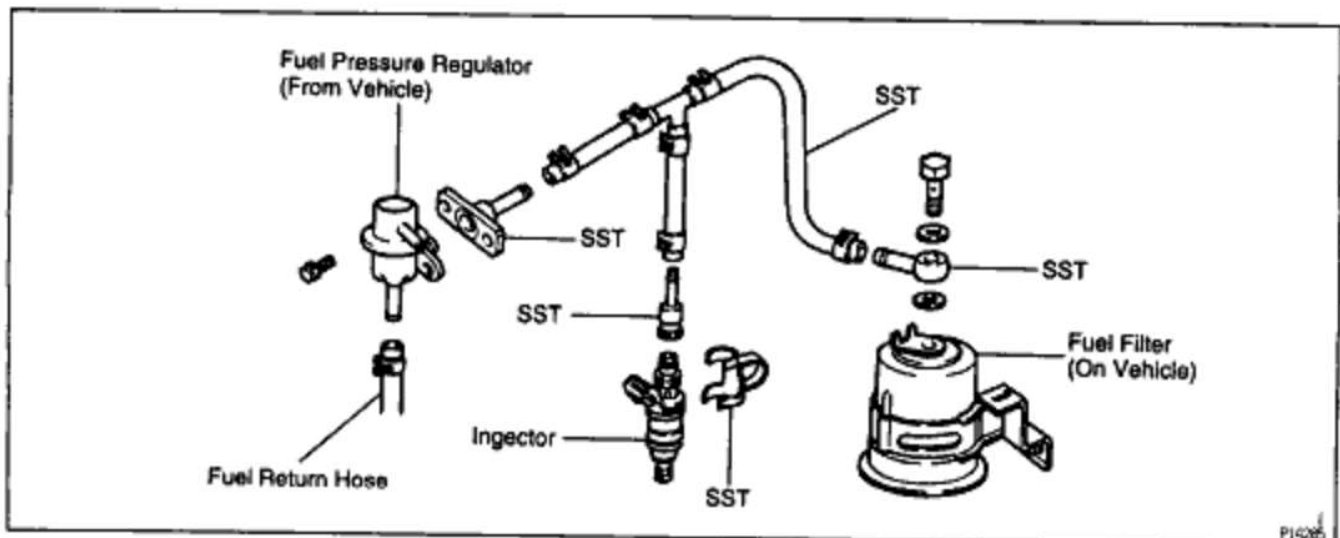

1MZ-FE ENGINE - SFI SYSTEM

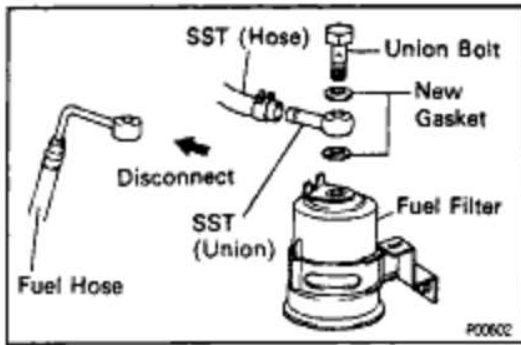

- (a) Disconnect the fuel hose from the fuel filter outlet.
 (b) Connect SST (union and hose) to the fuel filter outlet with 2 new gaskets and the union bolt.
 SST 09268-41045 (90405-09015)
 HINT: Use the vehicle's fuel filter.

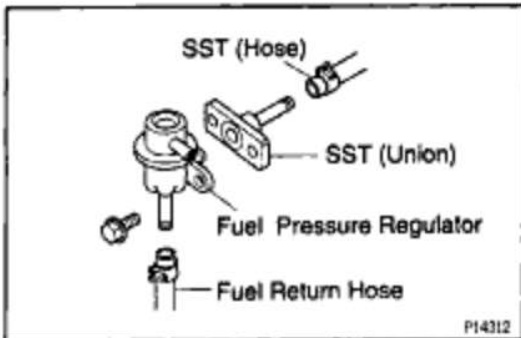

- (c) Remove the fuel pressure regulator.
 (d) Connect the fuel return hose, SST (hose) and SST (union) to the fuel pressure regulator.
 SST 09268-41045 (09268-41090)

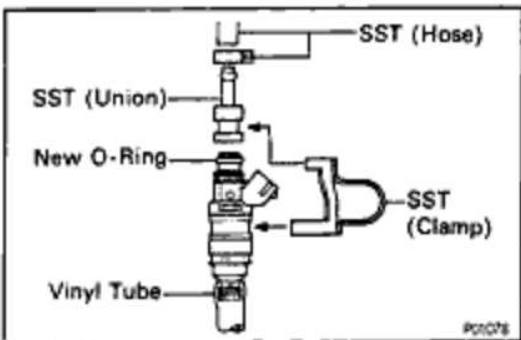

- (e) Install a new O-ring to the injector.
 (f) Connect SST (union and hose) to the injector, and hold the injector and union with SST (clamp).
 SST 09268-41045
 (g) Put the injector into the graduated cylinder.
 HINT: Install a suitable vinyl hose onto the injector to prevent gasoline from splashing out.

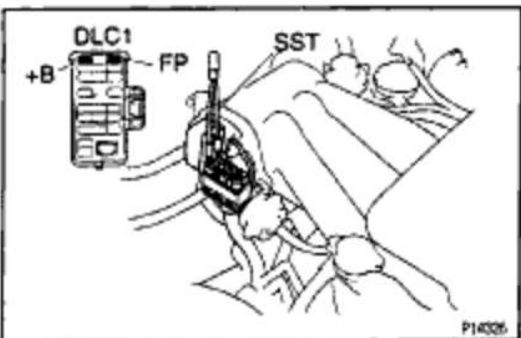

- (h) Using SST, connect terminals +B and FP of the DLC1.
 SST 00843-18020
 (i) Reconnect the negative (-) terminal cable to the battery.

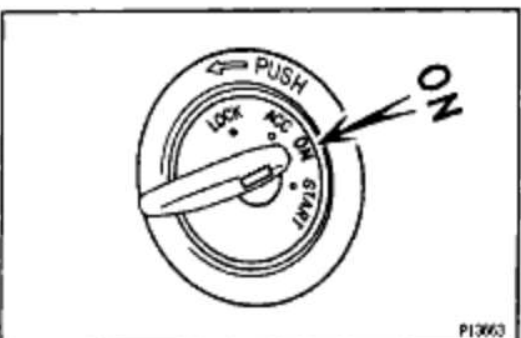

- (j) Turn the ignition switch ON.
NOTICE: Do not start the engine.

EG2-252

1MZ-FE ENGINE - FE ENGINE - SFI SYSTEM

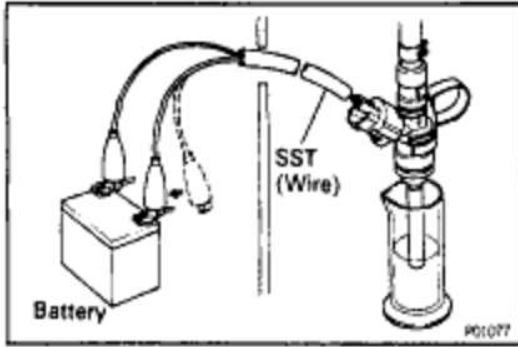

(k) Connect SST (wire) to the injector and battery for 15 seconds, and measure the injection volume with a graduated cylinder. Test each injector 2 or 3 times. SST 09842-30070

Volume:

54 – 64 cm³ (3.3 – 3.9 cu in.) per 15 sec.

Difference between each injector:

5 cm³ (0.3 cu in.) or less

If the ignition volume is not as specified, replace the injector.

2. INSPECT LEAKAGE

(a) In the condition above, disconnect the test probes of SST (wire) from the battery and check the fuel leakage from the injector.

SST 09842-30070

Fuel drop:

1 drop or less per minute

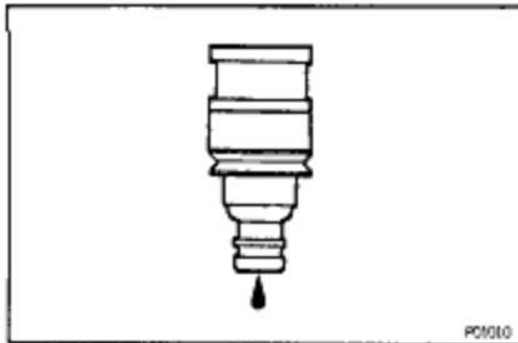

(b) Disconnect the negative (-) terminal cable to the battery.

(c) Remove SST.

SST 09268-41045 and 09843-18020

(d) Reinstall the fuel pressure regulator to the delivery pipe. (See step 1 on pages [EG2-241](#) and [242](#))

Torque: 8 N·m (80 kgf·cm, 69 in.-lbf)

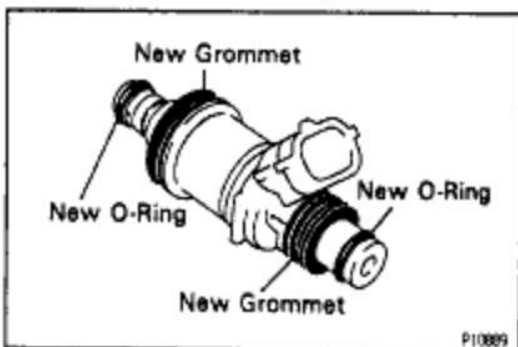
**INJECTORS INSTALLATION**

(See Components for Removal and Installation)

1. INSTALL INJECTORS AND DELIVERY PIPES

(a) Install 2 new grommets to each injector.

(b) Apply a light coat of spindle oil or gasoline to 2 new O-rings and install them to each injector.

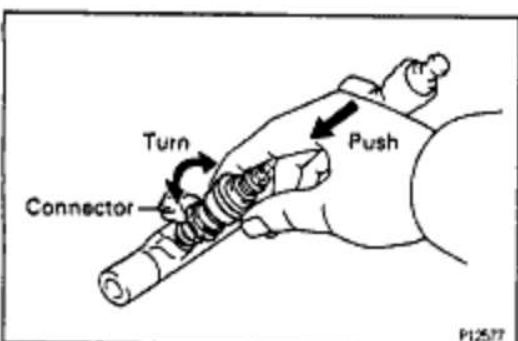

(c) While turning the injector clockwise and counter-clockwise, push it to the delivery pipes. Install the 6 injectors.

(d) Position the injector connector outward.

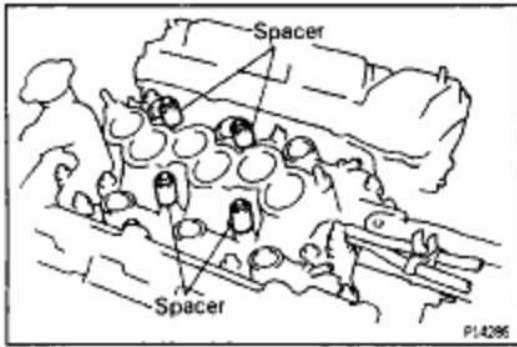

(e) Place the 4 spacers in position on the intake manifold.

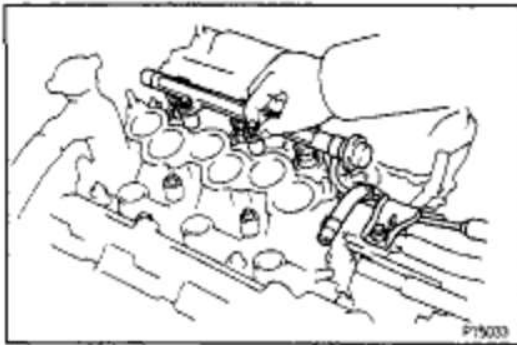

(f) Place the RH delivery pipe and No.1 fuel pipe together with the 3 injectors in position on the intake manifold.

(g) Temporarily install the 2 bolts holding the RH delivery pipe to the intake manifold.

(h) Temporarily install the bolt holding the No.1 fuel pipe to the intake manifold.

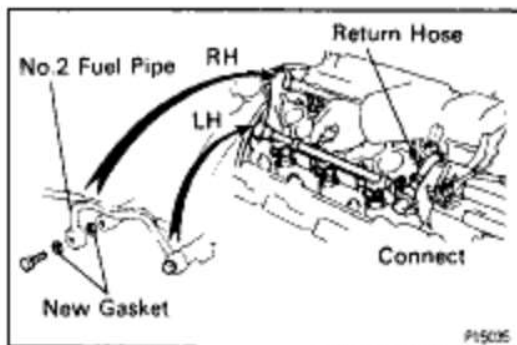

(i) Place the LH delivery pipe and No.2 fuel pipe together with the 3 injectors in position on the intake manifold.

(j) Connect the fuel return hose to the fuel pressure regulator.

(k) Temporarily install the 2 bolts holding the LH delivery pipe to the intake manifold.

(l) Temporarily install the No.2 fuel pipe to the LH delivery pipe with the union bolt and 2 new gaskets.

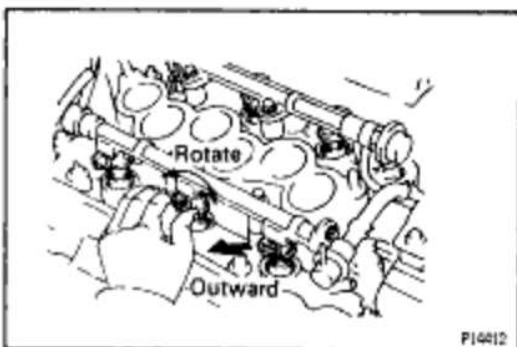

(m) Check that the injectors rotate smoothly.

HINT: If injectors do not rotate smoothly, the probable cause is incorrect installation of O-rings. Replace the O-rings.

(n) Position the injector connector outward.

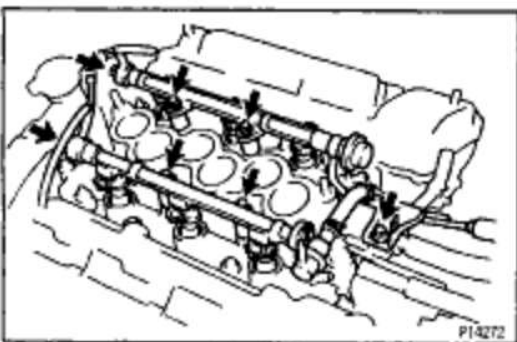

(o) Tighten the 4 bolts holding the delivery pipes to the intake manifold.

Torque: 10 N-m (100 kgf-cm, 7 ft-lbf)

(p) Tighten the bolt holding the No.1 fuel pipe to the intake manifold.

Torque: 19.5 N-m (200 kgf-cm, 14 ft-lbf)

(q) Tighten the 2 union bolts holding the No.2 fuel pipe to the delivery pipes.

Torque: 32.5 N-m (330 kgf-cm, 24 ft-lbf)

EG2-254

1MZ-FE ENGINE - SFI SYSTEM

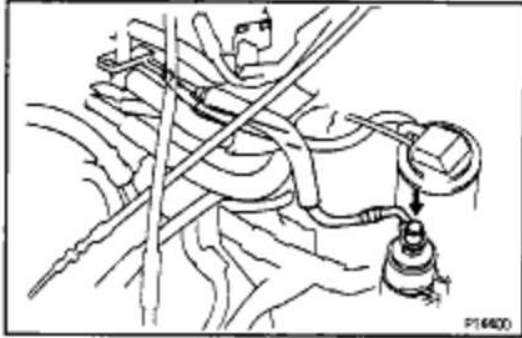
**2. CONNECT FUEL INLET AND RETURN HOSES**

(a) Connect the fuel inlet hose to the fuel filter with the 2 new gaskets and union bolt.

Torque: 30 N-m (300 kgf-cm, 22 ft-lbf)

(b) Connect the fuel return hose to the No.1 fuel pipe.
HINT: Pass the fuel return hose under the heater hoses.

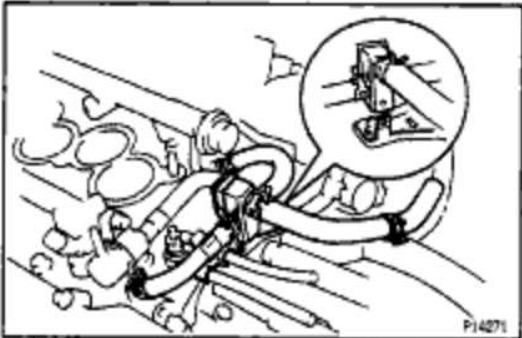
**3. INSTALL AIR ASSIST HOSES AND PIPE**

(a) Connect the air assist hoses to the intake manifold.

(b) Install the air assist pipe to the bracket on the No.1 fuel pipe.

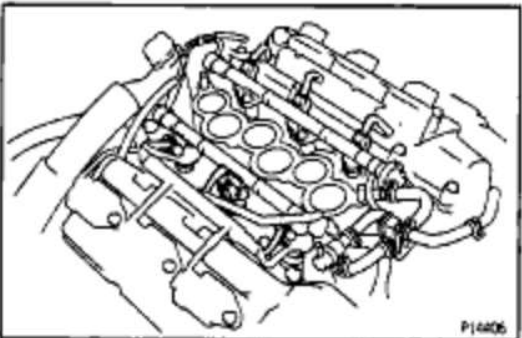
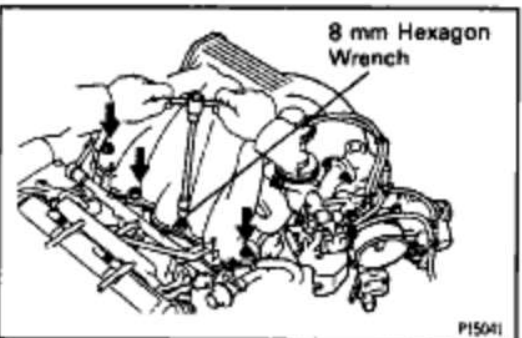
**4. CONNECT INJECTOR CONNECTORS****5. INSTALL AIR INTAKE CHAMBER ASSEMBLY**

(a) Using a 8 mm hexagon wrench, install a new gasket and the air intake chamber assembly with the 2 bolts and 2 nuts.

Torque: 43 N-m (440 kgf-cm, 32 ft-lbf)

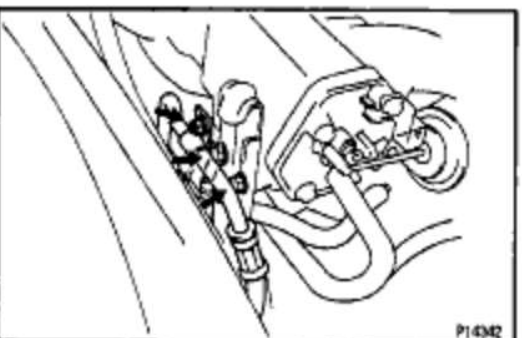

(b) Connect the ground strap with the bolt.

(c) Install the bolt holding the No.1 engine hanger to the air intake chamber.

Torque: 39 N-m (400 kgf-cm, 29 ft-lbf)

(d) Connect the PS pressure tube with the nut.

1MZ-FE ENGINE - SFI SYSTEM

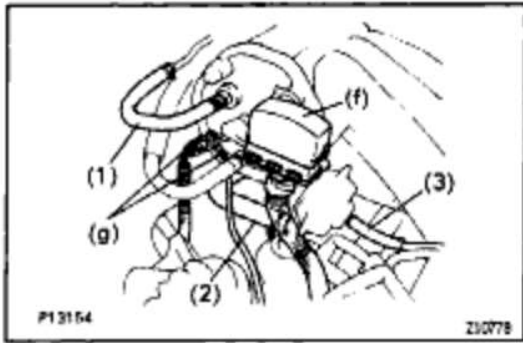

- (e) Connect the following hoses:
- (1) Brake booster vacuum hose
 - (2) PCV hose
 - (3) Actuator vacuum hose
- (f) Connect the DLC1.
 (g) Connect the 2 ground straps with the nut.
Torque: 14.5 N-m (145 kgf-cm. 10 ft-lbf)

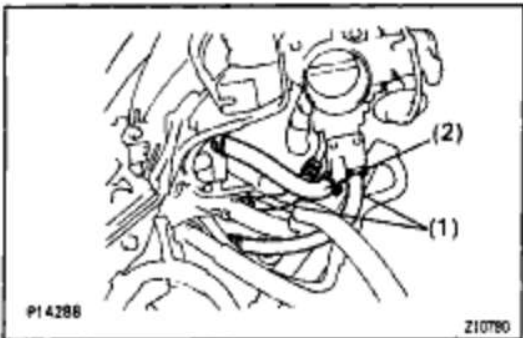

- (h) Connect the following hoses:
- (1) 2 water bypass hoses to throttle body
 - (2) Air assist hose to throttle body

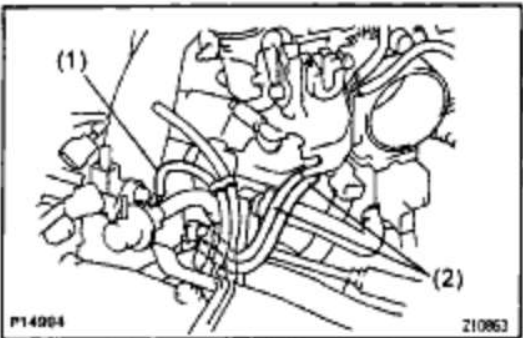

- (i) Connect the following vacuum hoses:
- (1) Vacuum hose to air intake chamber
 - (2) 2 vacuum hoses to throttle body

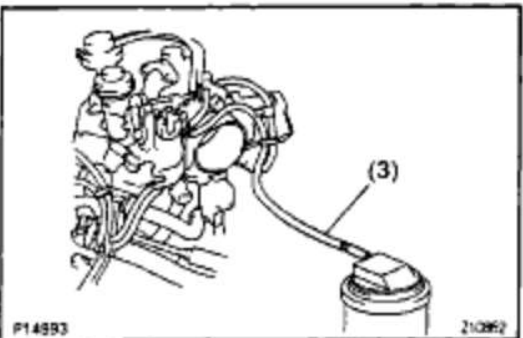

- (3) Vacuum hose to charcoal canister

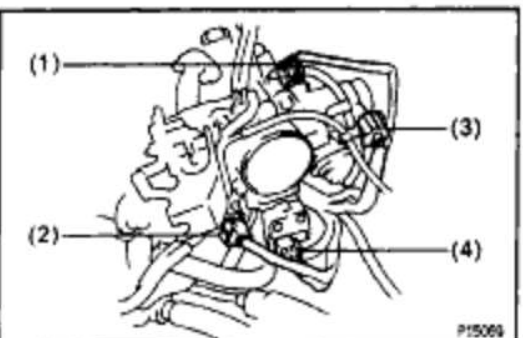

- (j) Connect the following connectors:
- (1) A/C idle-up valve connector
 - (2) EGR gas temperature sensor connector
 - (3) Throttle position sensor connector
 - (4) IAC valve connector

EG2-256

1MZ-FE ENGINE - FE ENGINE - SFI SYSTEM

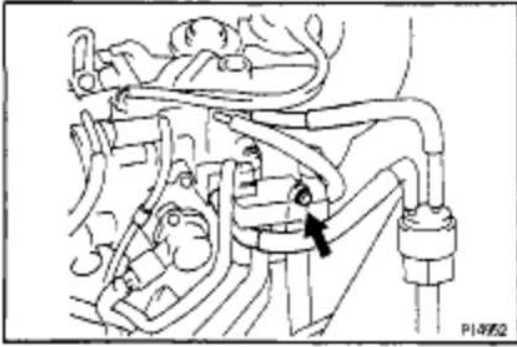

(k) Install the bolt holding the air intake chamber stay to the air intake chamber.

Torque: 19.5 N-m (200 kgf-cm, 14 ft-lbf)

(1) Connect the 2 PS air hoses.

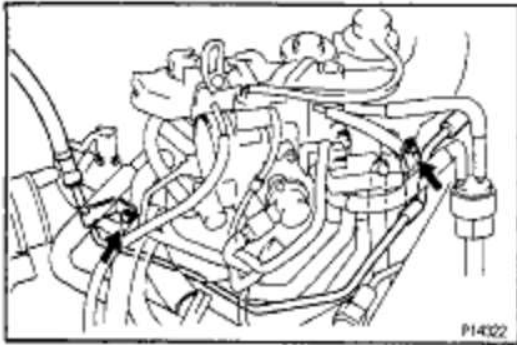

6. CONNECT HYDRAULIC MOTOR PRESSURE PIPE

Connect the pressure pipe to the air intake chamber and water inlet with the 2 bolts.

Torque: 8 N-m (80 kgf-cm, 69 in.-lbf)



7. INSTALL NO.2 EGR PIPE

Install 2 new gaskets and the EGR pipe with the 4 nuts.

Torque: 12 N-m (120 kgf-cm, 9 ft-lbf)

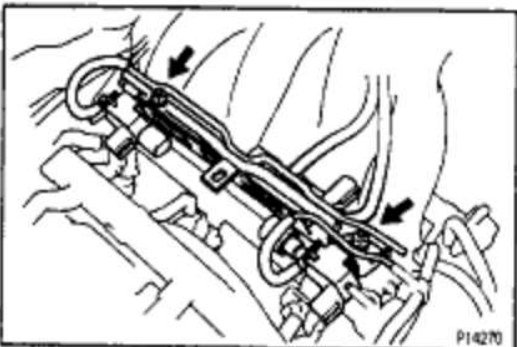

8. INSTALL EMISSION CONTROL VALVE SET

(a) Install the emission control valve set with 2 bolts.

Torque: 8 N-m (80 kgf-cm, 69 in.-lbf)

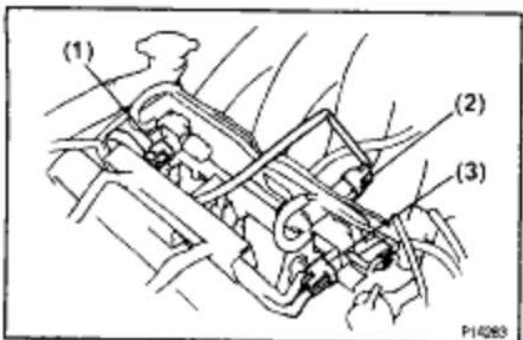

(b) Connect the following connectors:

- (1) VSV connector for ACIS
- (2) VSV connector for EGR
- (3) VSV connector for fuel pressure control

1MZ-FE ENGINE - SFI SYSTEM

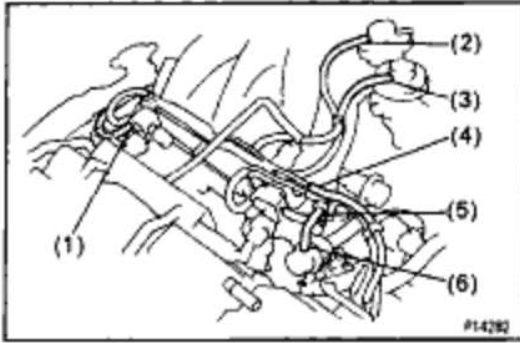

- (c) Connect the following vacuum hoses:
- (1) Vacuum hose to VSV for ACIS
 - (2) Vacuum hose to EGR vacuum modulator
 - (3) Vacuum hose to EGR valve
 - (4) Vacuum hose (from cylinder head rear plate)
 - (5) Vacuum hose from air intake chamber
 - (6) Vacuum hose to fuel pressure regulator

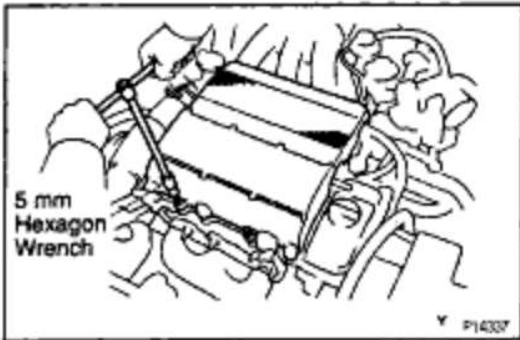
**9. INSTALL V-BANK COVER**

Using a 5 mm hexagon wrench, install the V- bank cover with the 2 cap nuts.

HINT: For fixing the V - bank cover, push on the cover until sense of "click" is felt.

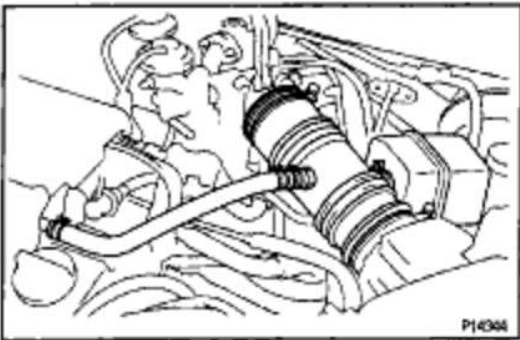
**10. INSTALL AIR CLEANER HOSE**

- (a) Connect the air cleaner hose with the 2 hose clamps.
- (b) Connect the PCV hose.

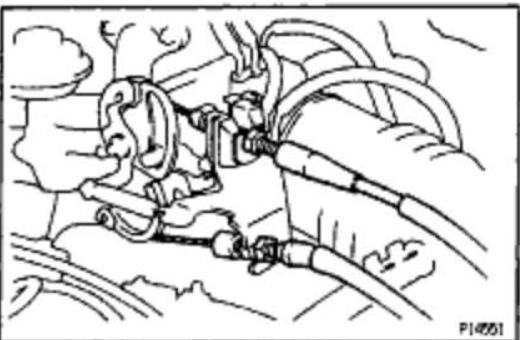
**11. CONNECT THROTTLE CABLE****12. CONNECT ACCELERATOR CABLE****13. FILL WITH ENGINE COOLANT**

Capacity:

8.7 liters (9.2 US qts. 7.7 Imp. qts)

14. CONNECT NEGATIVE (-) TERMINAL CABLE TO BATTERY

FUEL TANK AND LINE COMPONENTS

BOOK - 01

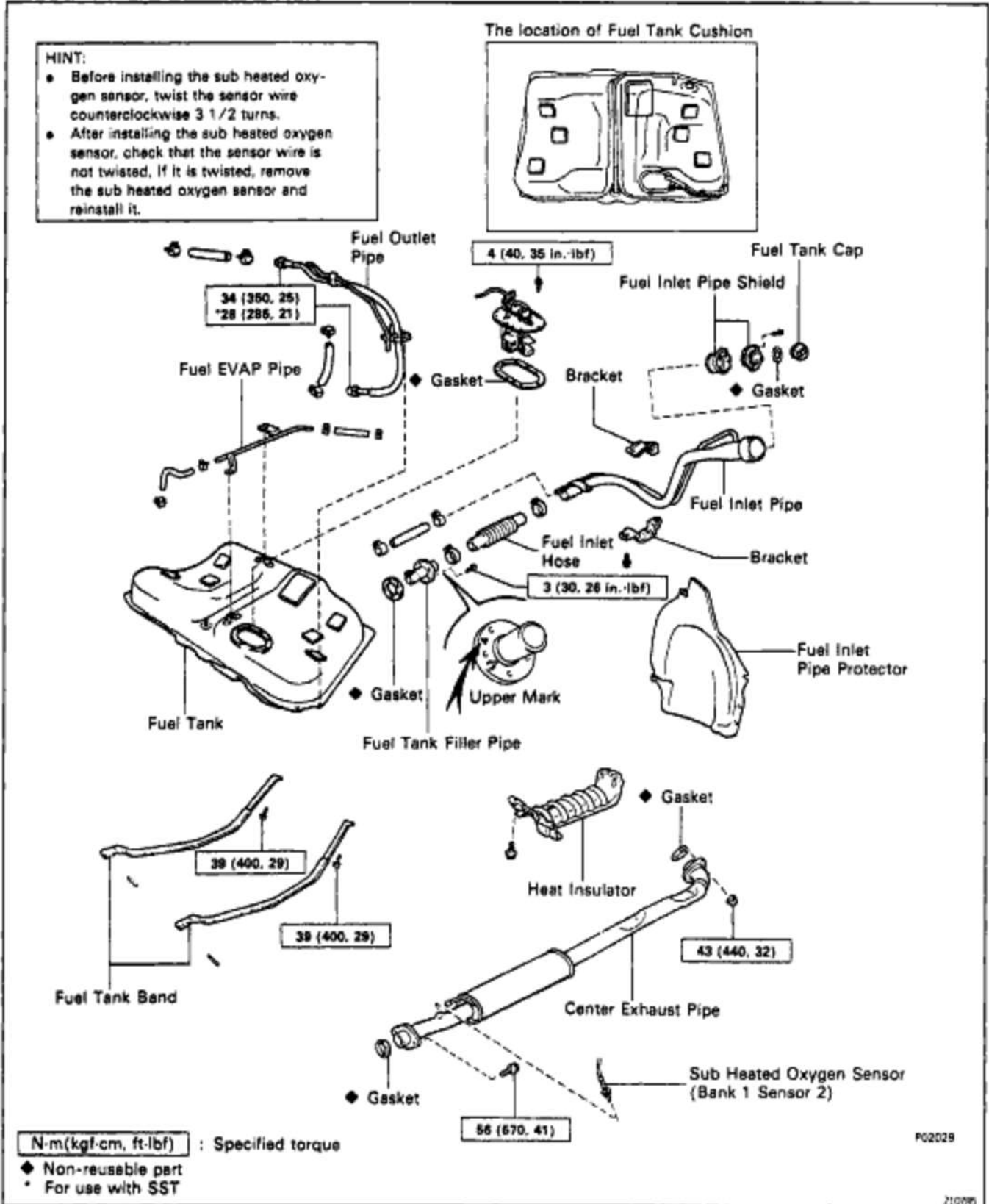

PRECAUTIONS

1. Always use new gaskets when replacing the fuel tank or component parts.
2. Apply the proper torque to all parts tightened.

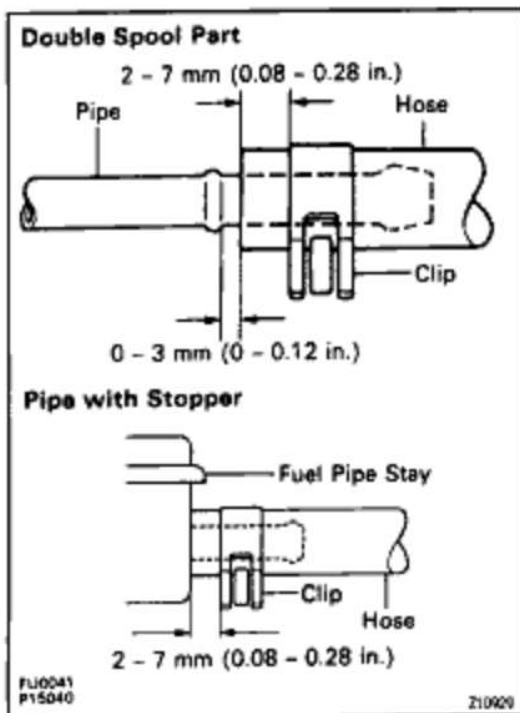
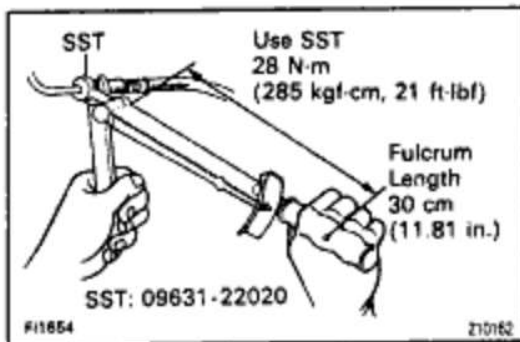
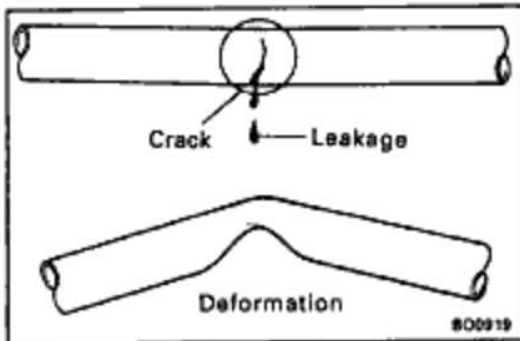

FUEL LINES AND CONNECTIONS INSPECTION

- (a) Check the fuel lines for cracks or leakage, and all connections for deformation.
- (b) Check the fuel tank vapor vent system hoses and connections for looseness, sharp bends or damage.
- (c) Check the fuel tank for deformation, cracks, fuel leakage or tank band looseness.
- (d) Check the filler neck for damage or fuel leakage.
- (e) Hose and pipe connections are as shown in the illustration.

If a problem is found, repair or replace the parts as necessary.

EG2-260

1MZ-FE ENGINE - SFI SYSTEM

MASS AIR FLOW (MAF) METER

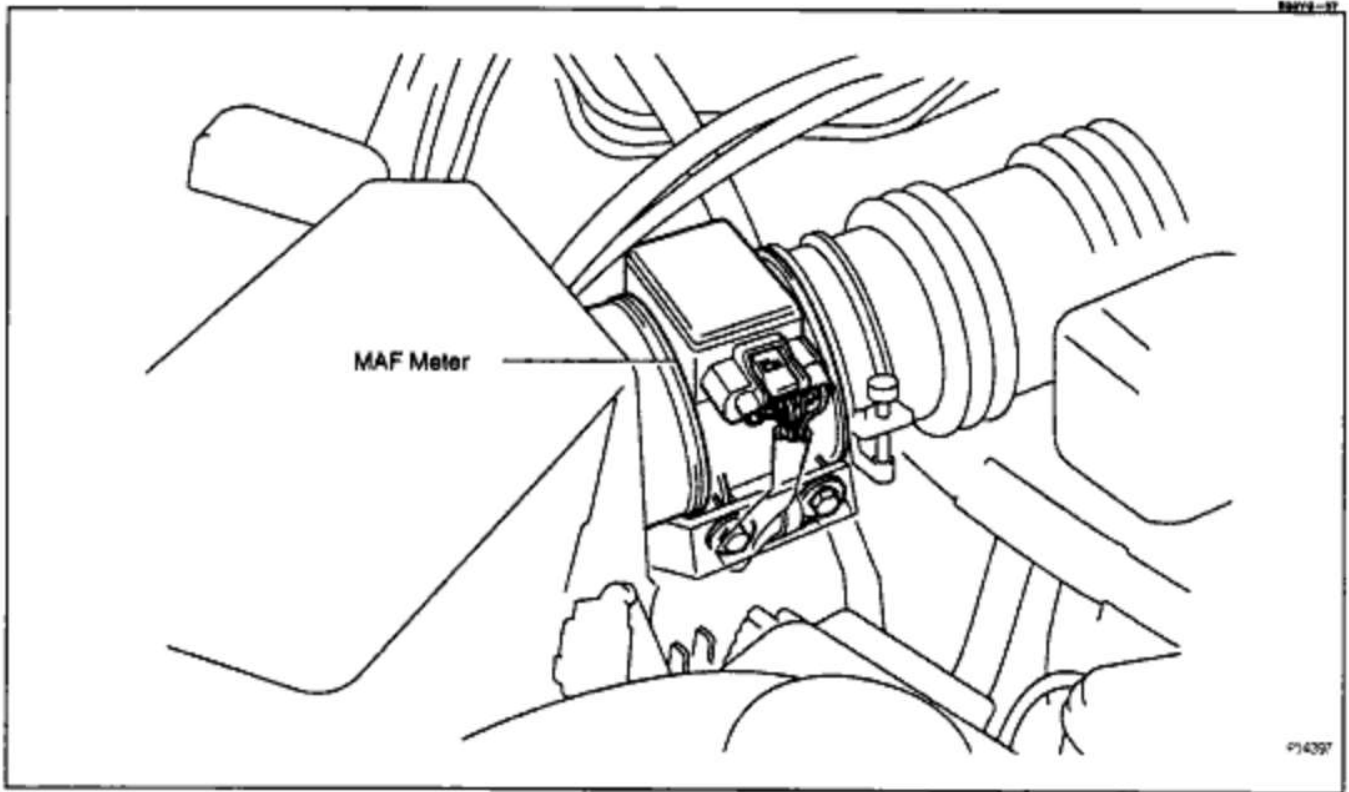

COMPONENTS FOR REMOVAL AND INSTALLATION

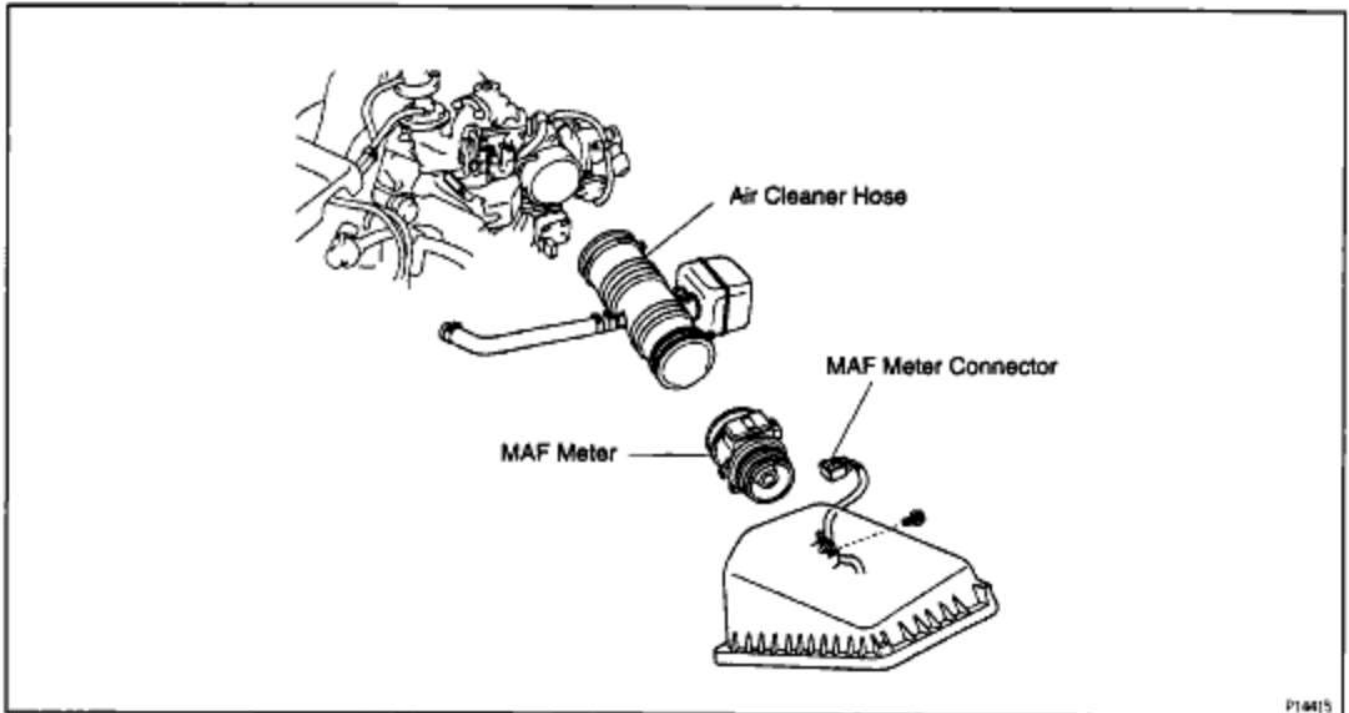

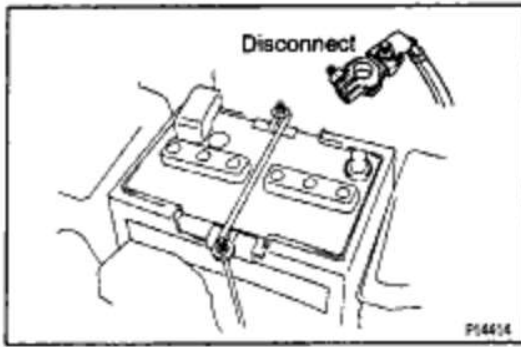

MAF METER REMOVAL

(See Components for Removal and Installation)

1. DISCONNECT NEGATIVE (-) TERMINAL CABLE FROM BATTERY

CAUTION: Work must be started after 90 seconds from the time the Ignition switch is turned to the 'LOCK' position and the negative (-) terminal cable is disconnected from the battery.



2. REMOVE AIR CLEANER NOSE

- (a) Disconnect the PCV hose.
- (b) Loosen the 2 hose clamps, and remove the air cleaner hose.

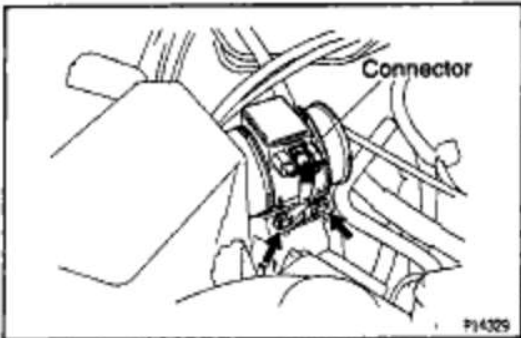

3. REMOVE MAP METER

- (a) Disconnect the MAF meter connector.
- (b) Remove the 2 bolts and MAF meter.

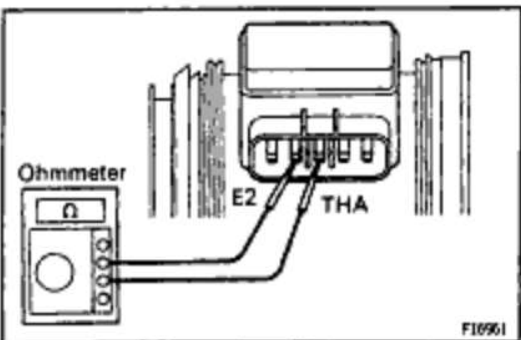

MAF METER INSPECTION

1. INSPECT MAF METER RESISTANCE

Using an ohmmeter, measure the resistance between terminals THA and E2.

Between terminals	Resistance	Temperature
THA - E2	10-20k Ω	- 20° C (-4° F)
THA - E2	4 -7k Ω	0° C (32° F)
THA - E2	2 -3k Ω	20° C (68° F)
THA - E2	0.9 - 1.3 k Ω	40° C (104° F)
THA = E2	0.4 - 0.7 k Ω	60° C (140° F)

If the resistance is not as specified, replace the MAF meter.

EG2-262

1MZ-FE ENGINE - SFI SYSTEM

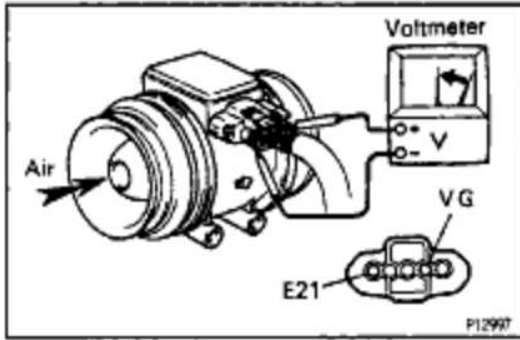
**2. INSPECT MAF METER OPERATION**

- (a) Connect the MAF meter connector.
 - (b) Using a voltmeter, connect the positive (+) tester probe to terminal VG, and negative (-) tester probe to terminal E21.
 - (c) Blow air into the MAF meter, and check that the voltage fluctuates.
- If operation is not as specified, replace the MAF meter.

- (d) Disconnect the MAF meter connector.

MAF METER INSTALLATION

(See Components for Removal and Installation)

1. INSTALL MAF METER

- (a) Insert the MAF meter end into the air cleaner case.
- (b) Install the MAF meter with the 2 bolts.

Torque: 6.9 N-m (70 kgf-cm, 61 in.-lbf)

- (c) Connect the MAF meter connector.

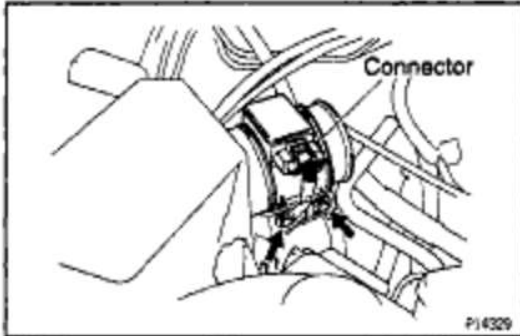
**2. INSTALL AIR CLEANER HOSE**

- (a) Install the air cleaner hose with the 2 hose clamps.
- (b) Connect the PCV hose.

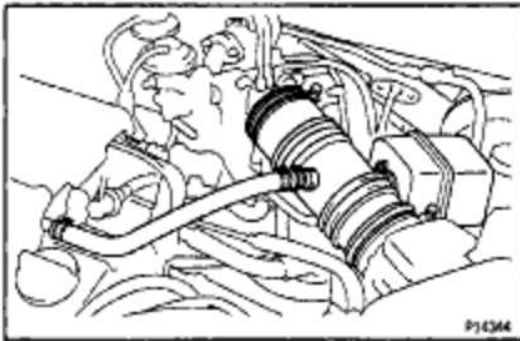
**3. CONNECT NEGATIVE (-) TERMINAL CABLE TO BATTERY**

THROTTLE BODY

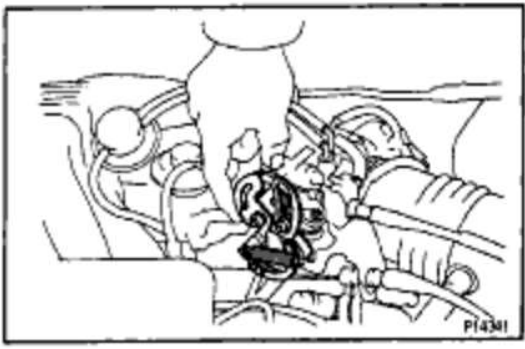
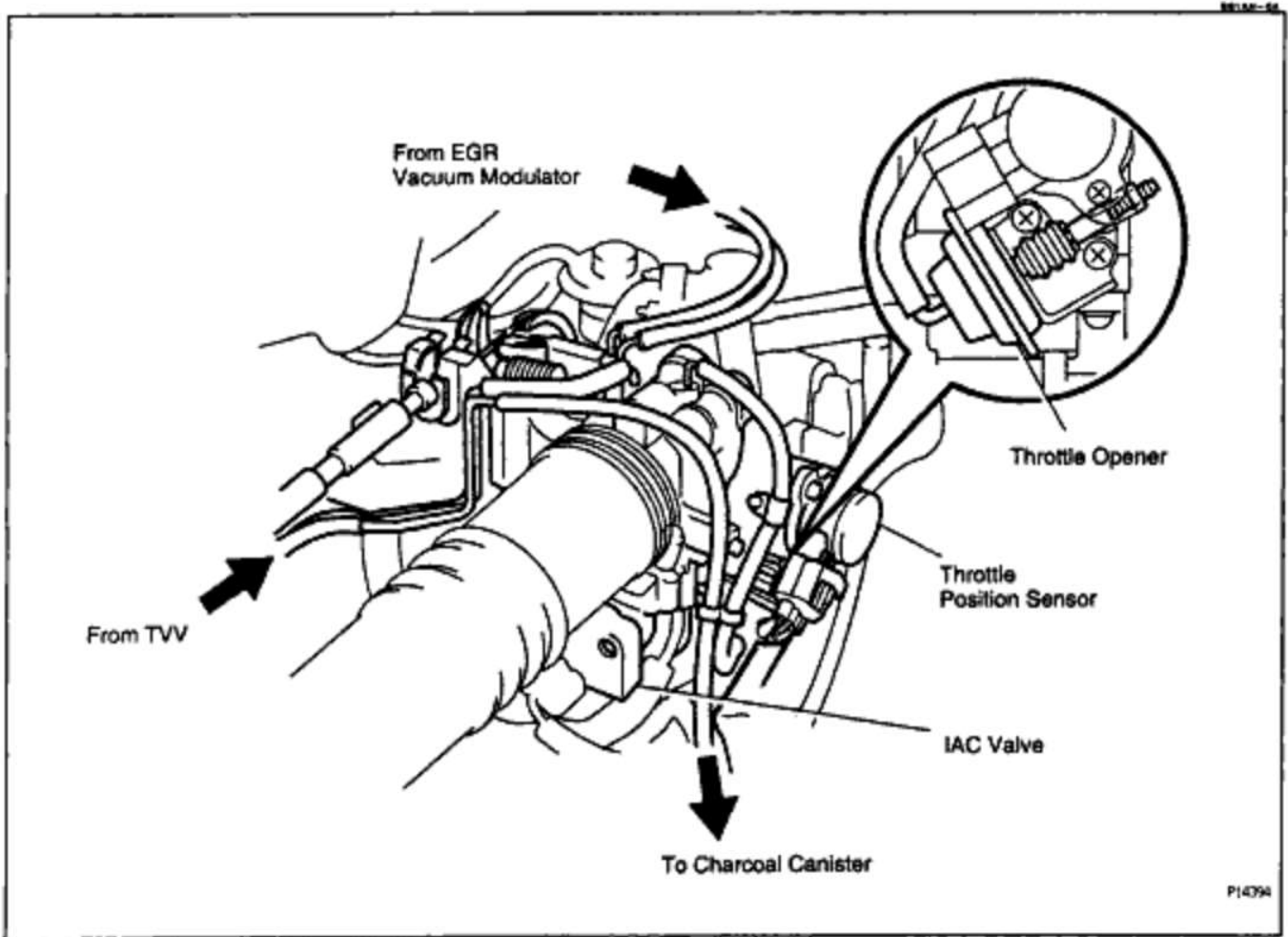

ON-VEHICLE INSPECTION

1. INSPECT THROTTLE BODY

(a) Check that the throttle linkage moves smoothly.

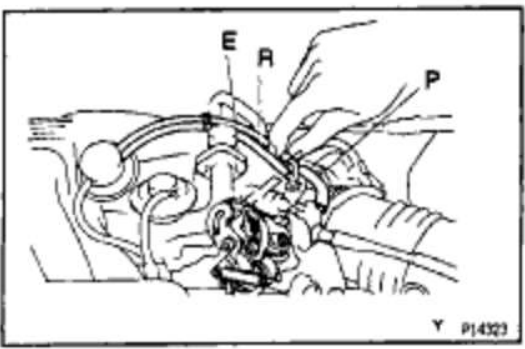

(b) Check the vacuum at each port.

- Start the engine.
- Check the vacuum with your finger.

Port name	At idle	3,000 rpm or more
P	No vacuum	Vacuum
E	No vacuum	Vacuum
R	No vacuum	Vacuum

EG2-264

1MZ-FE ENGINE - SFI SYSTEM

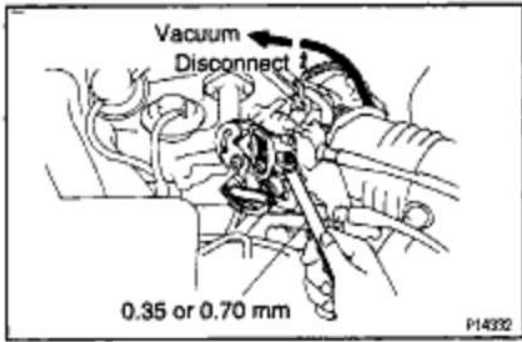

2. INSPECT THROTTLE POSITION SENSOR

- (a) Apply vacuum to the throttle opener.
- (b) Disconnect the sensor connector.
- (c) Insert a thickness gauge between the throttle stop screw and stop lever.

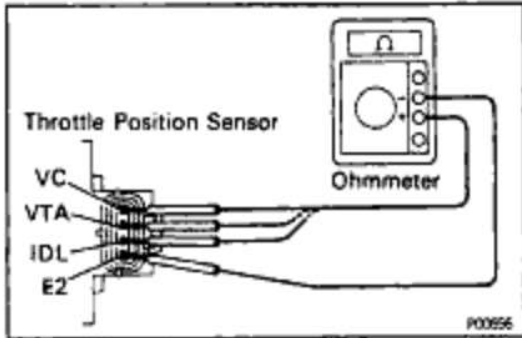

- (d) Using an ohmmeter, measure the resistance between each terminal.

Clearance between feather and stop screw	Between terminals	Resistance
0 mm (0 in.)	VTA - E2	0.28 - 6.4 kΩ
0.35 mm (0.014 in.)	IDL - E2	0.5 kΩ or less
0.70 mm (0.028 in.)	IDL - E2	Infinity
Throttle valve fully open	VTA - E2	2.0 - 11.6 kΩ
-	VC - E2	2.7 - 7.7 kΩ

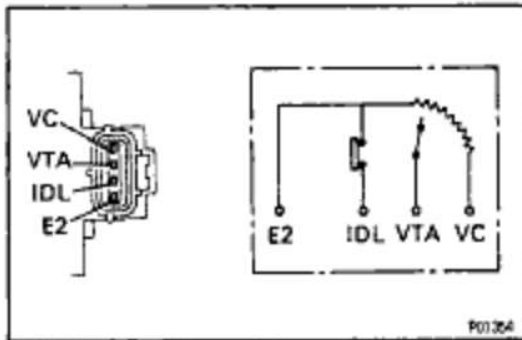

- (e) Reconnect the sensor connector.

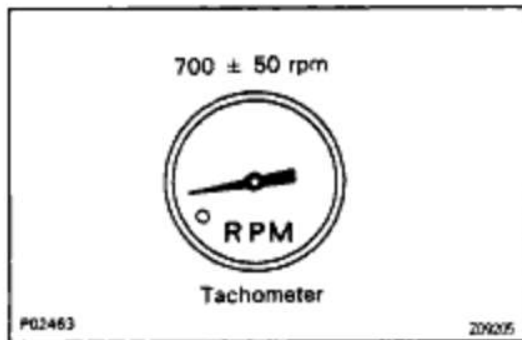

3. INSPECT THROTTLE OPENER

A. Warm up engine

Allow the engine to warm up to normal operating temperature.

B. Check idle speed

Idle speed:

700 ± 50 rpm

C. Check throttle opener setting speed

- (a) Disconnect the vacuum hose from the throttle opener, and plug the hose end.

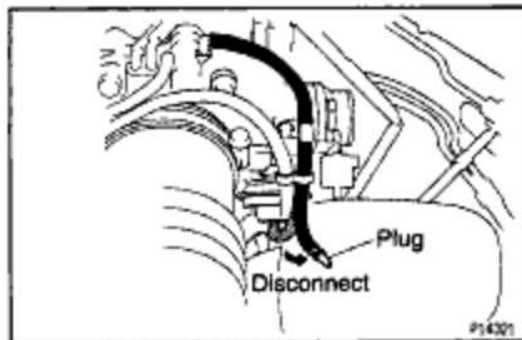

1MZ-FE ENGINE - SFI SYSTEM

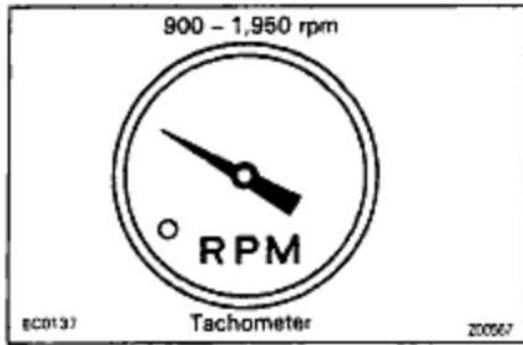

(b) Check the throttle opener setting speed.

Throttle opener setting speed:

900-1,950 rpm

If the throttle opener setting is not as specified, re-
place the throttle body.

(c) Stop the engine.

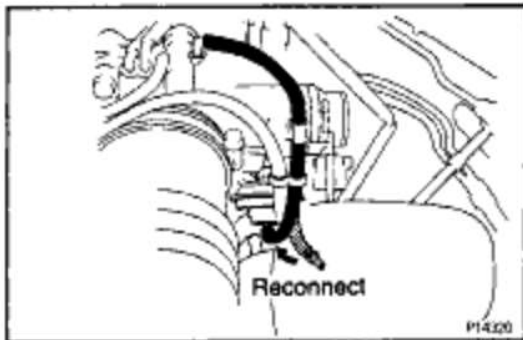

(d) Reconnect the vacuum hose to the throttle opener.

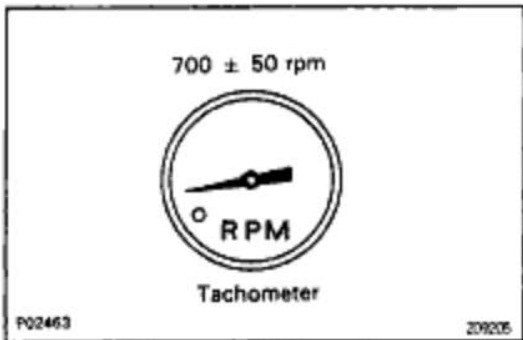

(e) Start the engine and check that the idle speed returns
to the correct speed.

EG2-266

1MZ-FE ENGINE - SFI SYSTEM

COMPONENTS FOR REMOVAL AND INSTALLATION

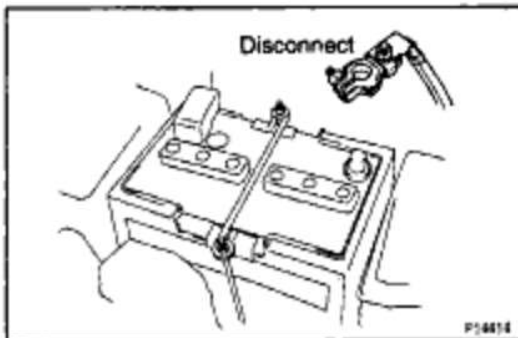
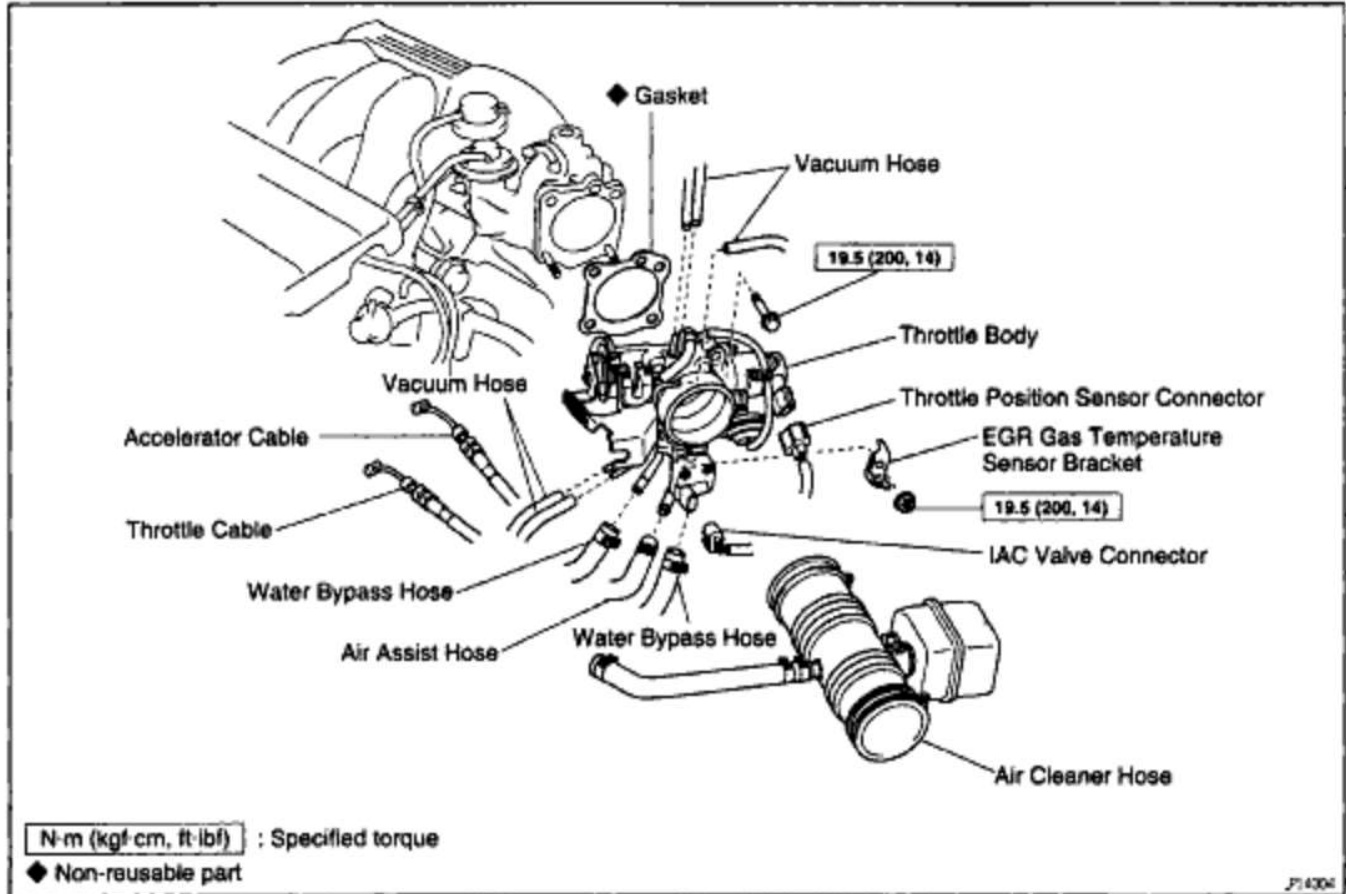

THROTTLE BODY REMOVAL

(See Components for Removal and Installation)

1. DISCONNECT NEGATIVE (-) TERMINAL CABLE FROM BATTERY

CAUTION: Work must be started after 90 seconds from the time the ignition switch is turned to the 'LOCK' position and the negative (-) terminal cable is disconnected from the battery.

2. DRAIN ENGINE COOLANT

3. DISCONNECT ACCELERATOR CABLE

4. DISCONNECT THROTTLE CABLE

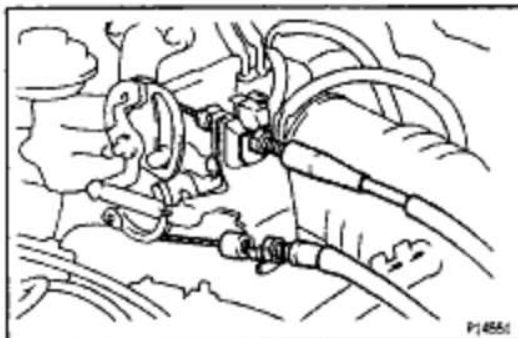

1MZ-FE ENGINE - SFI SYSTEM

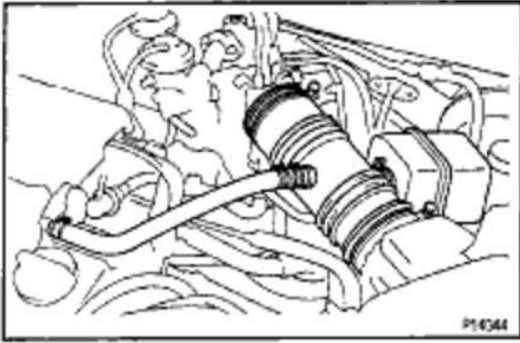
**5. REMOVE AIR CLEANER HOSE**

- (a) Disconnect the PCV hose.
- (b) Loosen the 2 hose clamps, and remove the air cleaner hose.

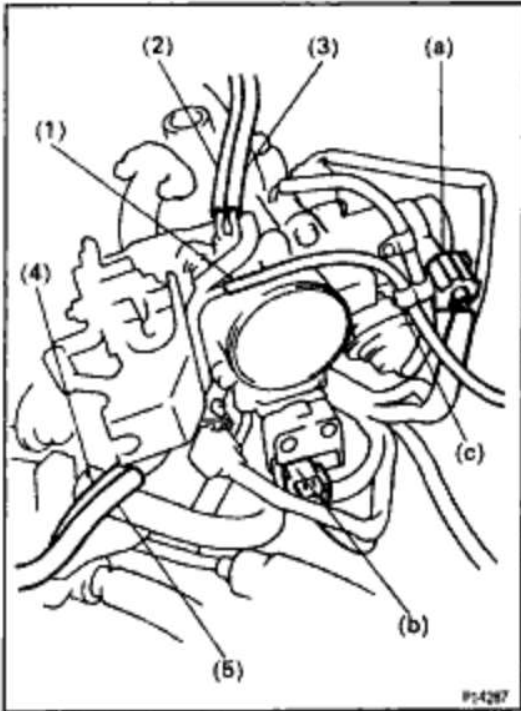
**6. REMOVE THROTTLE BODY**

- (a) Disconnect the throttle position sensor connector.
- (b) Disconnect the IAC valve connector.
- (c) Remove the hose clamp.
- (d) Disconnect the following vacuum hoses:
 - (1) Vacuum hose (from charcoal canister)
 - (2) Vacuum hose (from port R of EGR vacuum modulator)
 - (3) Vacuum hose (from port E of EGR vacuum modulator)
 - (4) Vacuum hose (from upper port of TVV)
 - (5) Vacuum hose (from lower port of TVV)

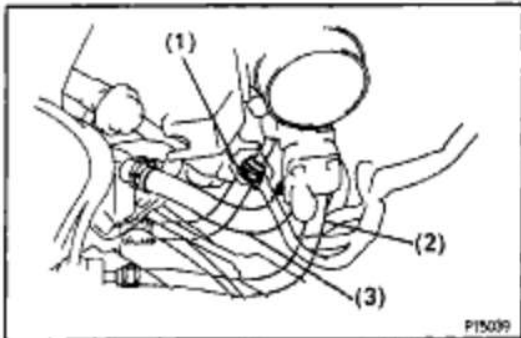

- (e) Disconnect the following hoses:
 - (1) Water bypass hose (from intake manifold)
 - (2) Water bypass hose (from water inlet housing)
 - (3) Air assist hose

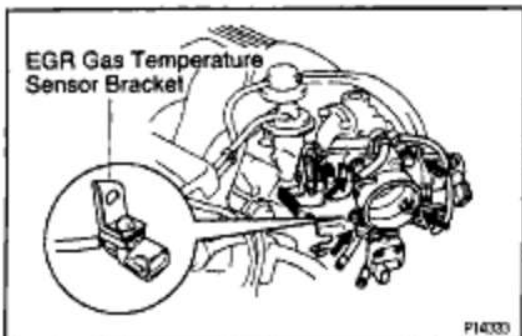

- (f) Remove the 2 bolts, 2 nuts, EGR gas temperature sensor bracket, throttle body and gasket.

EG2-268

1MZ-FE ENGINE - SFI SYSTEM

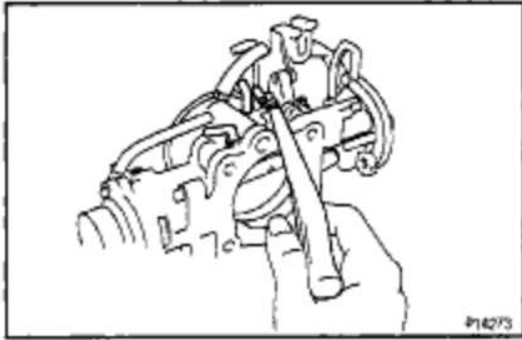

THROTTLE BODY INSPECTION

1. CLEAN THROTTLE BODY

- (a) Using a soft brush and carburetor cleaner, clean the cast parts.
- (b) Using compressed air, clean all the passages and apertures.

NOTICE: To prevent deterioration, do not clean the throttle position sensor.

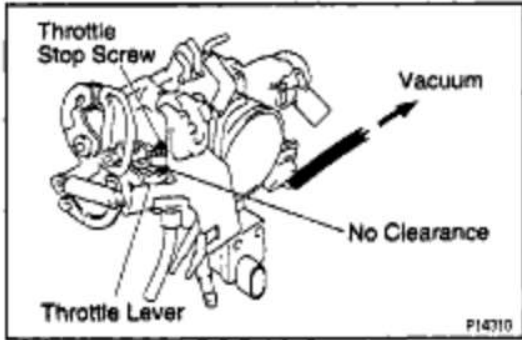

2. INSPECT THROTTLE VALVE

- (a) Apply vacuum to the throttle opener.
- (b) Check that there is no clearance between the throttle stop screw and throttle lever when the throttle valve is fully closed.

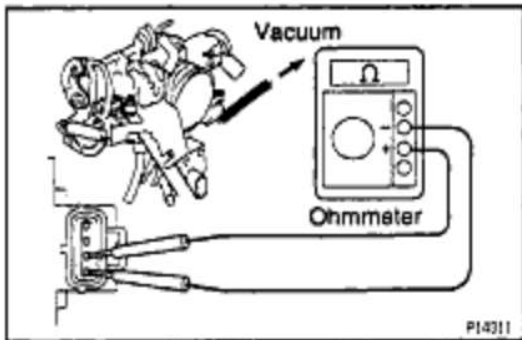

3. INSPECT THROTTLE POSITION SENSOR

- (a) Apply vacuum to the throttle opener.
- (b) Insert a thickness gauge between the throttle stop screw and stop lever.
- (c) Using an ohmmeter, measure the resistance between each terminal.

Clearance between lever and stop screw	Between terminals	Resistance
0 mm (0 in.)	VTA - E2	0.28 - 6.4 kΩ
0.35 mm (0.014 in.)	IDL - E2	0.5 k(Ω or less
0.70 mm (0.028 in.)	IDL - E2	Infinity
Throttle valve fully open	VTA - E2	2.0 - 11.6 k Ω
-	VC - E2	2.7 - 7.7 kΩ

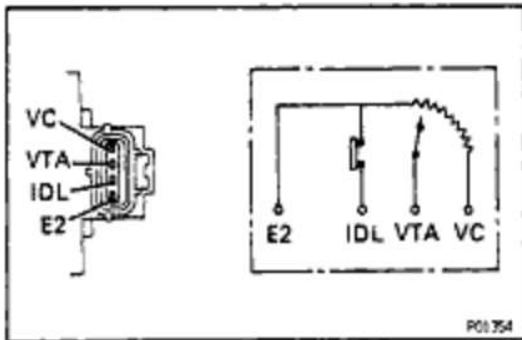

4. IF NECESSARY, ADJUST THROTTLE POSITION SENSOR

- (a) Loosen the 2 set screws of the sensor.

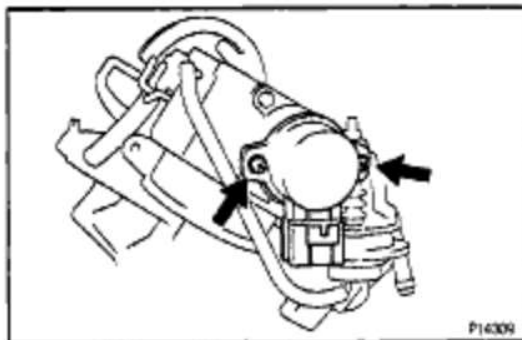

1MZ-FE ENGINE - SFI SYSTEM

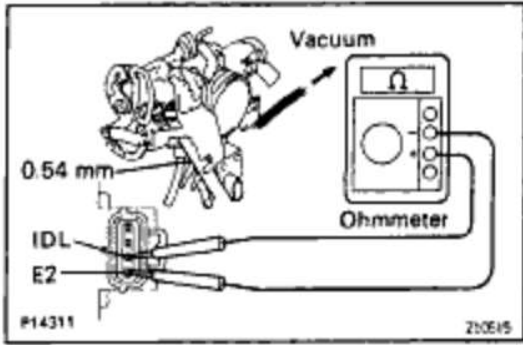

- (b) Apply vacuum to the throttle opener.
- (c) Insert a 0.54 mm (0.021 in.) thickness gauge, between the throttle stop screw and stop lever.
- (d) Connect the test probe of an ohmmeter to the terminals IDL and E2 of the sensor.
- (e) Gradually turn the sensor clockwise until the ohmmeter deflects, and secure it with the 2 set screws.

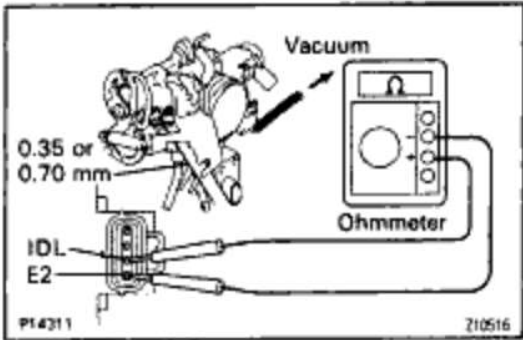

- (f) Recheck the continuity between terminals IDL and E2.

Clearance between lever and stop screw	Continuity (IDL - E2)
0.35 mm (0.014 in.)	Continuity
0.70 mm (0.028 in.)	No continuity

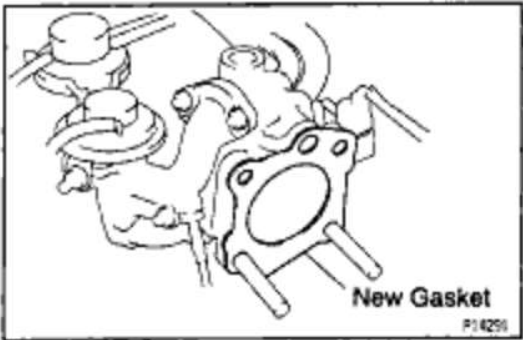

THROTTLE BODY INSTALLATION

(See Components for Removal and Installation)

1. INSTALL THROTTLE BODY

- (a) Place a new gasket on the air intake chamber.

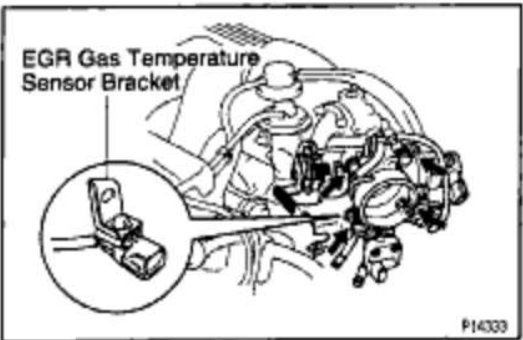

- (b) Install the throttle body, EGR gas temperature sensor bracket with the 2 bolts and 2 nuts.

Torque: 19.5 N-m (200 kgf-cm, 14 ft-lbf)

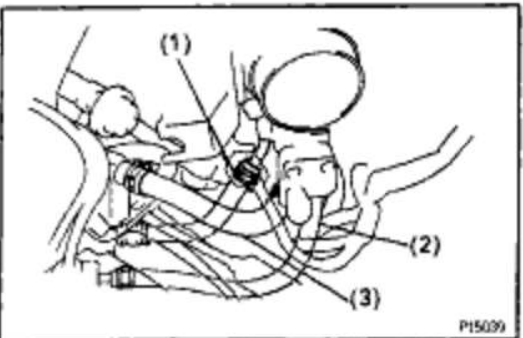

- (c) Connect the following hoses:
 - (1) Water bypass hose (from intake manifold)
 - (2) Water bypass hose (from water inlet housing)
 - (3) Air assist hose

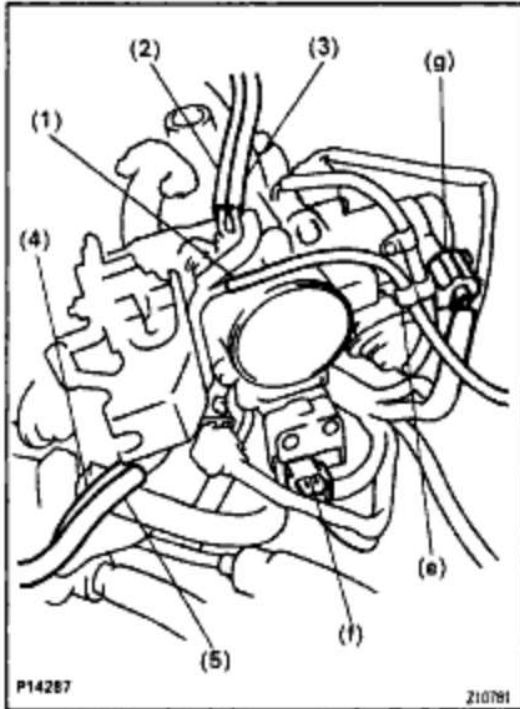
EG2-270**1MZ-FE ENGINE - SFI SYSTEM**

- (d) Connect the following vacuum hoses:
- (1) Vacuum hose (from charcoal canister)
 - (2) Vacuum hose (from port R of EGR vacuum modulator)
 - (3) Vacuum hose (from port R of EGR vacuum modulator)
 - (4) Vacuum hose (from upper port of TVV)
 - (5) Vacuum hose (from lower port of TVV)
- (e) Install the hose clamp.
 (f) Connect the IAC valve connector.
 (g) Connect the throttle position sensor connector.

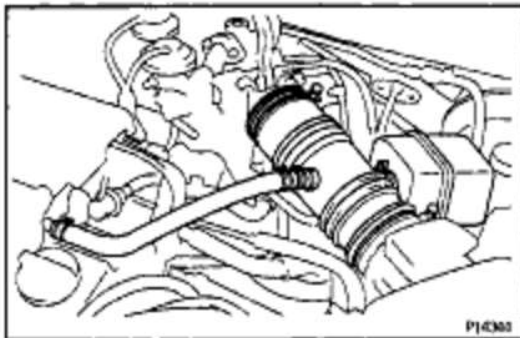
**2. INSTALL AIR CLEANER HOSE**

- (a) install the air cleaner hose with the 2 hose clamps.
 (b) Connect the PCV hose.

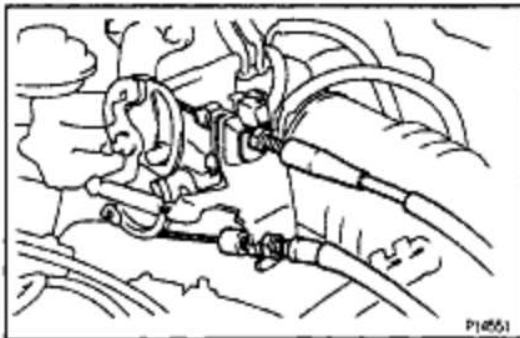
**3. CONNECT THROTTLE CABLE****4. CONNECT ACCELERATOR CABLE****5. FILL WITH ENGINE COOLANT**

Capacity:

8.7 liters (9.2 US qts, 7.7 Imp.qts)

6. CONNECT NEGATIVE (-) TERMINAL CABLE TO BATTERY

IDLE AIR CONTROL (IAC) VALVE

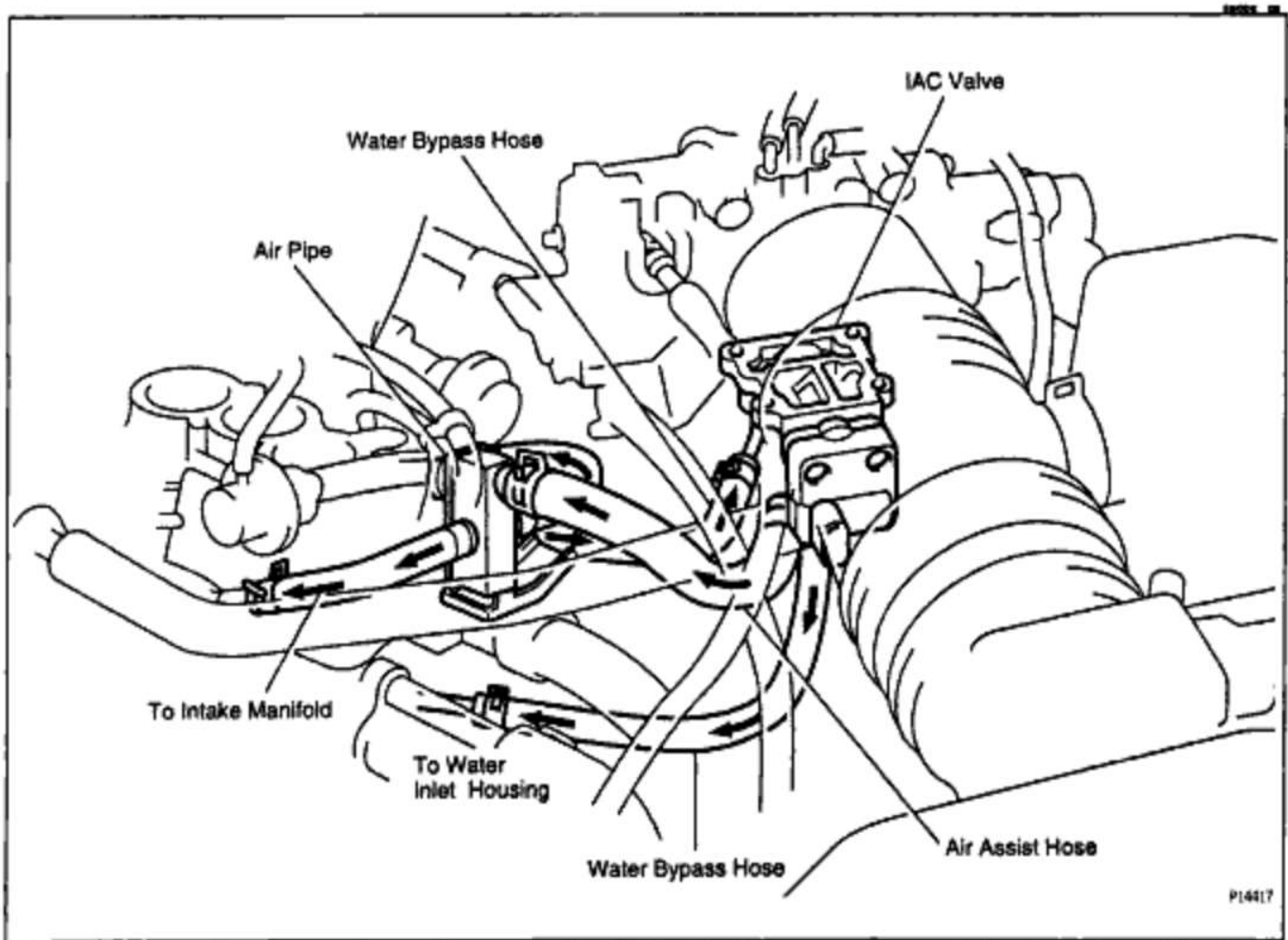

ON-VEHICLE INSPECTION

1. INSPECT IAC VALVE OPERATION

(a) Initial conditions:

- Engine at normal operating temperature
- Idle speed set correctly
- Transmission in neutral position
- A/C switch OFF

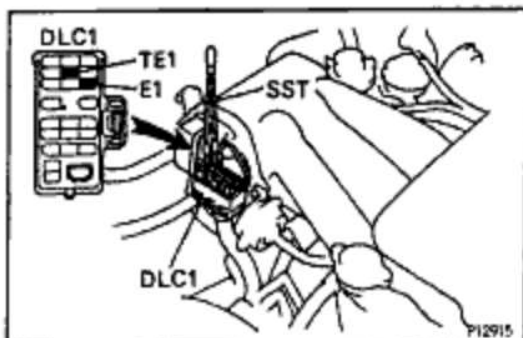

(b) Using SST, connect terminals TE1 and E1 of the DLC 1.

SST 09843-18020

(c) After engine speed are kept at approx. 1,000 rpm for 5 seconds, check that they return to idle speed.

If the engine speed operation is not as specified, check the IAC valve, wiring and ECM.

EG2-272

1MZ-FE ENGINE - SFI SYSTEM

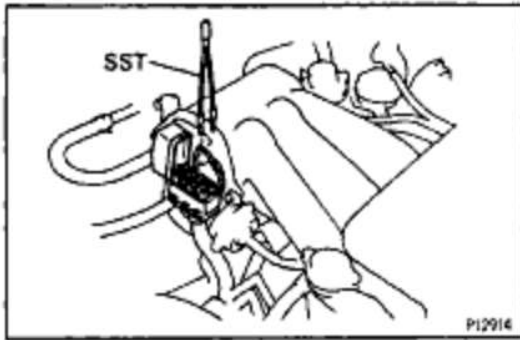

- (d) Remove the SST from the DLC1.
SST 09843-18020

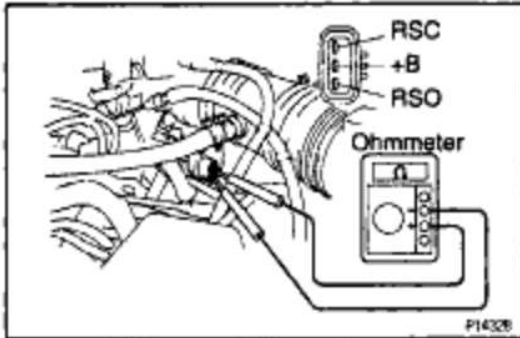
**2. INSPECT IAC VALVE RESISTANCE**

- (a) Disconnect the IAC valve connector.
(b) Using an ohmmeter, measure the resistance between terminal +B and other terminals (RSC, RSO).

Resistance:

19.3 – 22.3Ω at 20°C (68°F)

If resistance is not as specified, replace the IAC valve.

- (c) Reconnect the IAC valve connector.

3. INSPECT AIR ASSIST SYSTEM

- (a) Initial conditions:
- Engine at normal operating temperature
 - Idle speed set correctly
 - Transmission in neutral position
 - A/C switch OFF

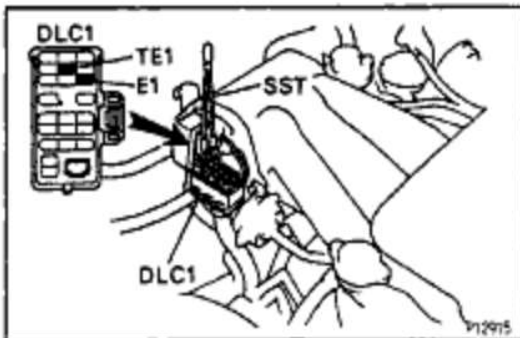

- (b) Using SST, connect terminals TE1 and E1 of the DLC1.

SST 09843-18020

- (c) After engine speed are kept at 900 – 1,300 rpm for 10 seconds, check that they return to idle speed.

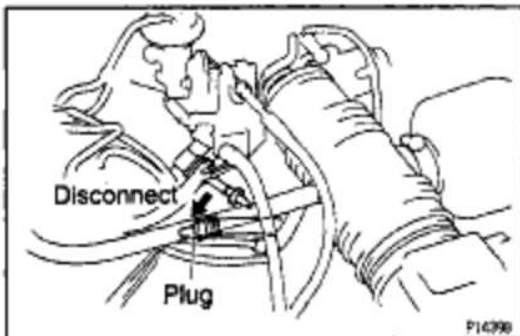

- (d) Stop the engine.

- (e) Disconnect the air assist hose from the air pipe, and block off the IAC valve exit and the entry to the pipe.

- (f) Start the engine and check that the idle speed reaches 500 rpm or below (the engine may stall).

If the idle does not reach 500 rpm or below, check for a leak between the air pipe and injector.

1MZ-FE ENGINE - SFI SYSTEM

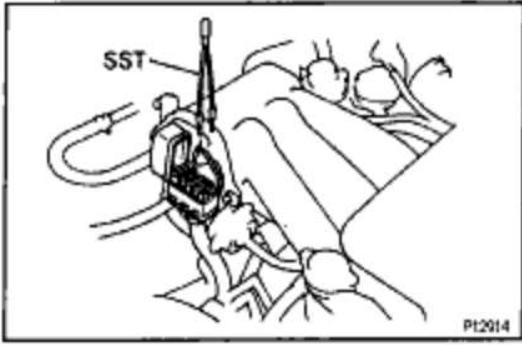

- (g) Remove the SST from the DLC 1.
SST 09843-18020
- (h) Reconnect the air assist hose to the air pipe.

COMPONENTS FOR REMOVAL AND INSTALLATION

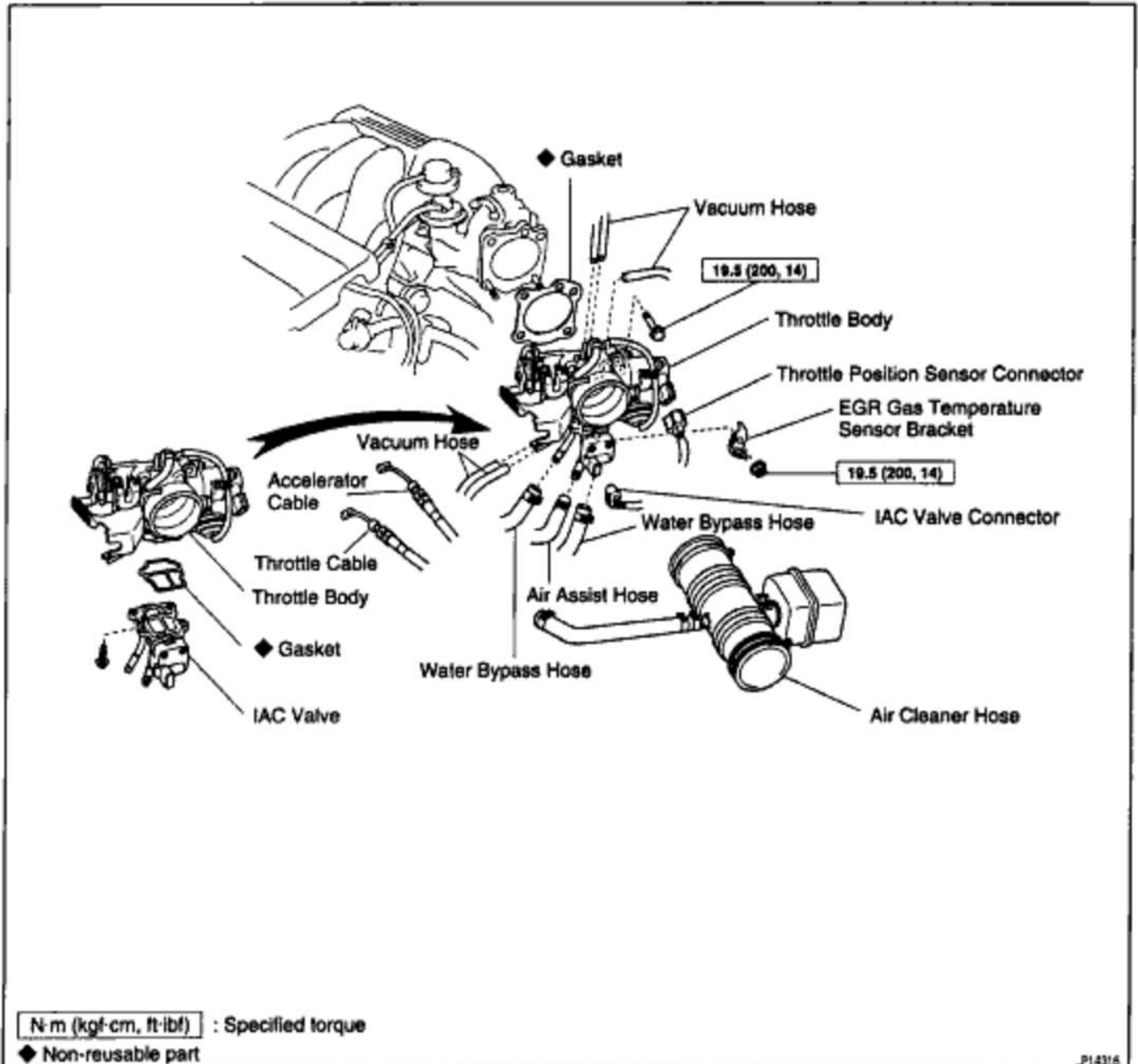

EG2-274

1MZ-FE ENGINE - SFI SYSTEM

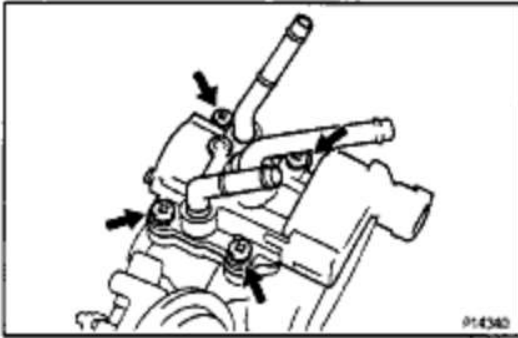
**IAC VALVE REMOVAL**

(See Components for Removal and Installation)

1. REMOVE THROTTLE BODY(See page [EG2-266](#))**2. REMOVE IAC VALVE**

Remove the 4 screws, IAC valve and gasket.

88130-06

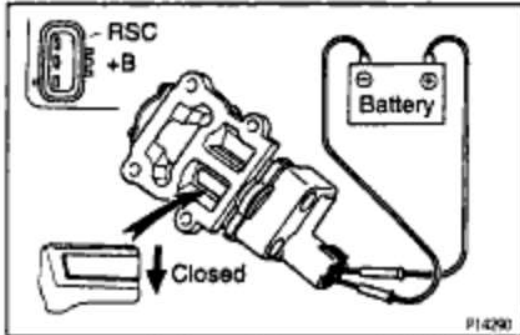
**IAC VALVE INSPECTION****INSPECT IAC VALVE OPERATION**

(a) Connect the positive (+) lead from the battery to terminal +B and negative (-) lead to terminal RSC, and check that the valve is closed.

88091-0A

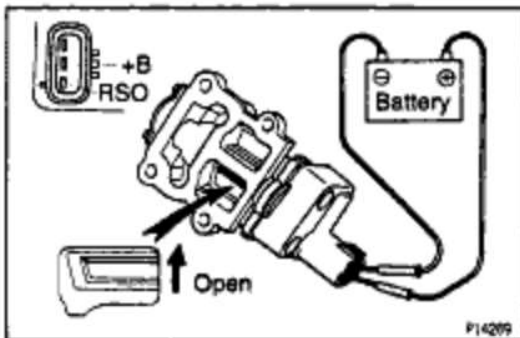

(b) Connect the positive (+) lead from the battery to terminal +B and negative (-) lead to terminal RSO, and check that the valve is open.

If operation is not as specified, replace the IAC valve.

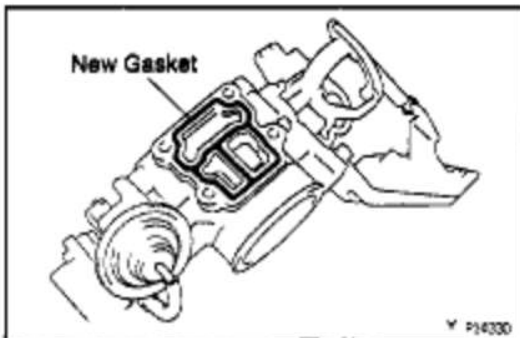
**IAC VALVE INSTALLATION**

(See Components for Removal and Installation)

1. INSTALL IAC VALVE

(a) Place a new gasket on the throttle body.

88091-01

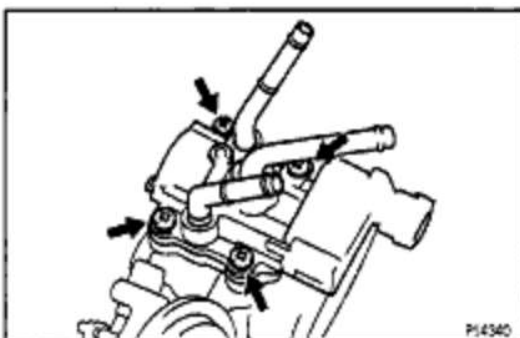

(b) Install the IAC valve with the 4 screws.

2. INSTALL THROTTLE BODY(See page [EG2-269](#))

ACOUSTIC CONTROL INDUCTION SYSTEM (ACIS)

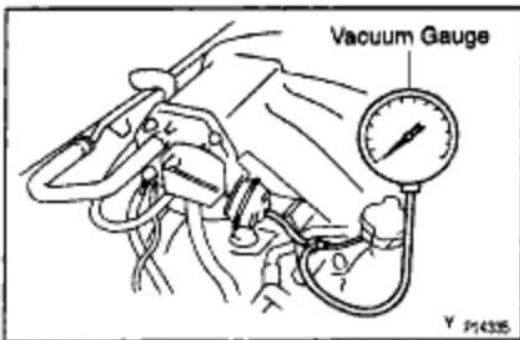
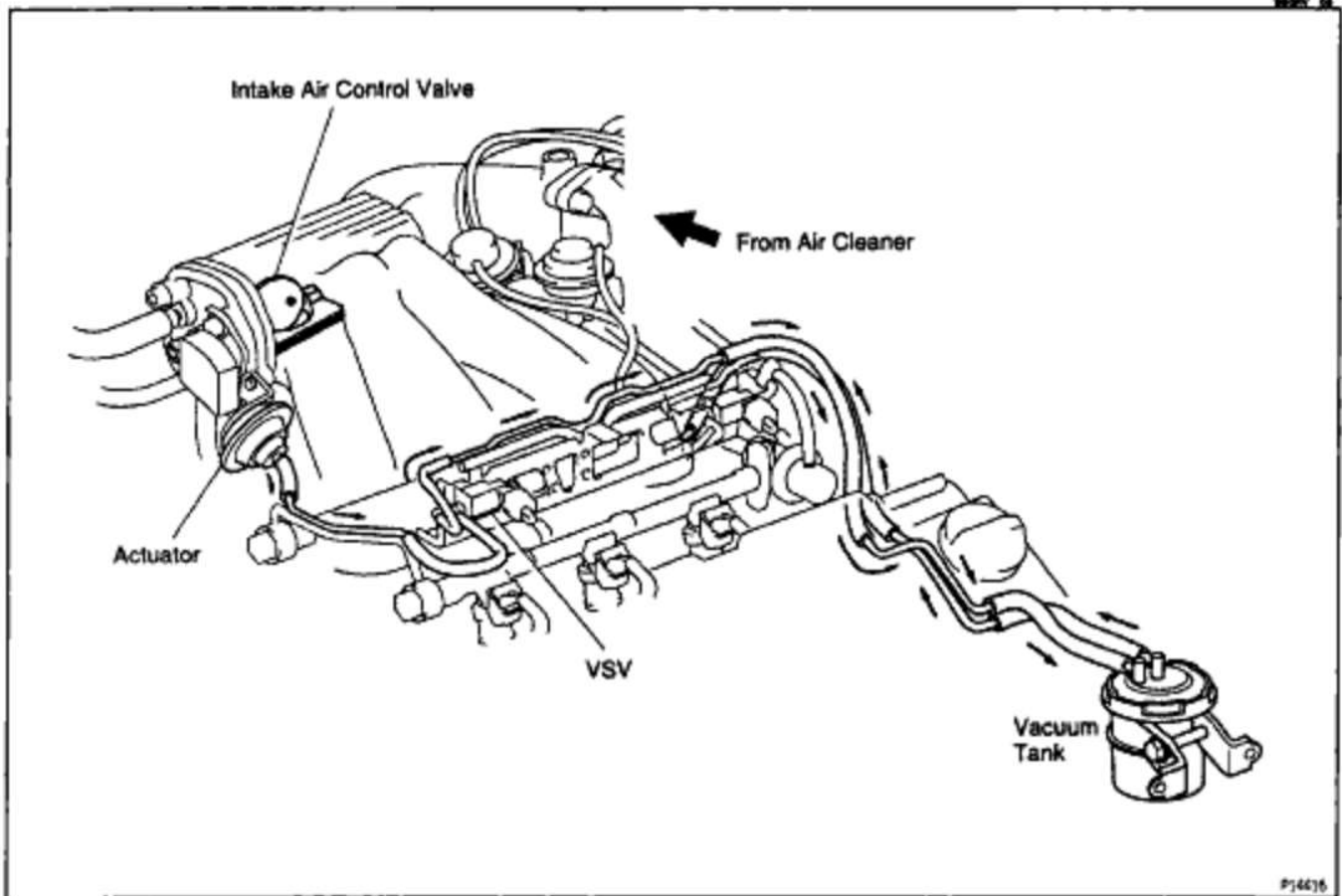

ON-VEHICLE INSPECTION INSPECT INTAKE AIR CONTROL VALVE

- Using a 3-way connector, connect vacuum gauge to the actuator hose.
- Start the engine.
- While the engine is idling, check that the vacuum gauge needle does not move.

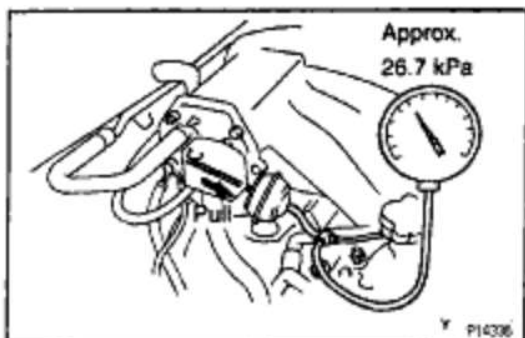

- Rapidly depress the accelerator pedal to fully open position and check that the vacuum gauge needle momentarily fluctuates up to approx. 26.7 kPa (200 mmHg, 7.9 in.Hg). (The actuator rod is pulled out.)

EG2-276

1MZ-FE ENGINE - SFI SYSTEM

COMPONENTS FOR INTAKE AIR CONTROL VALVE REMOVAL AND INSTALLATION

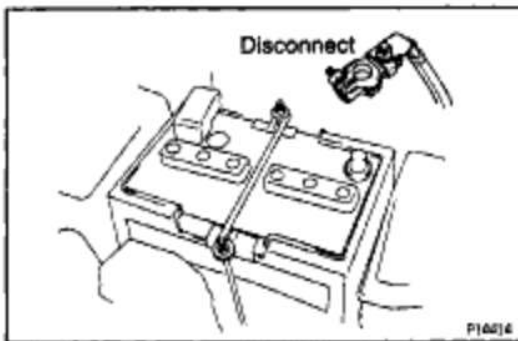
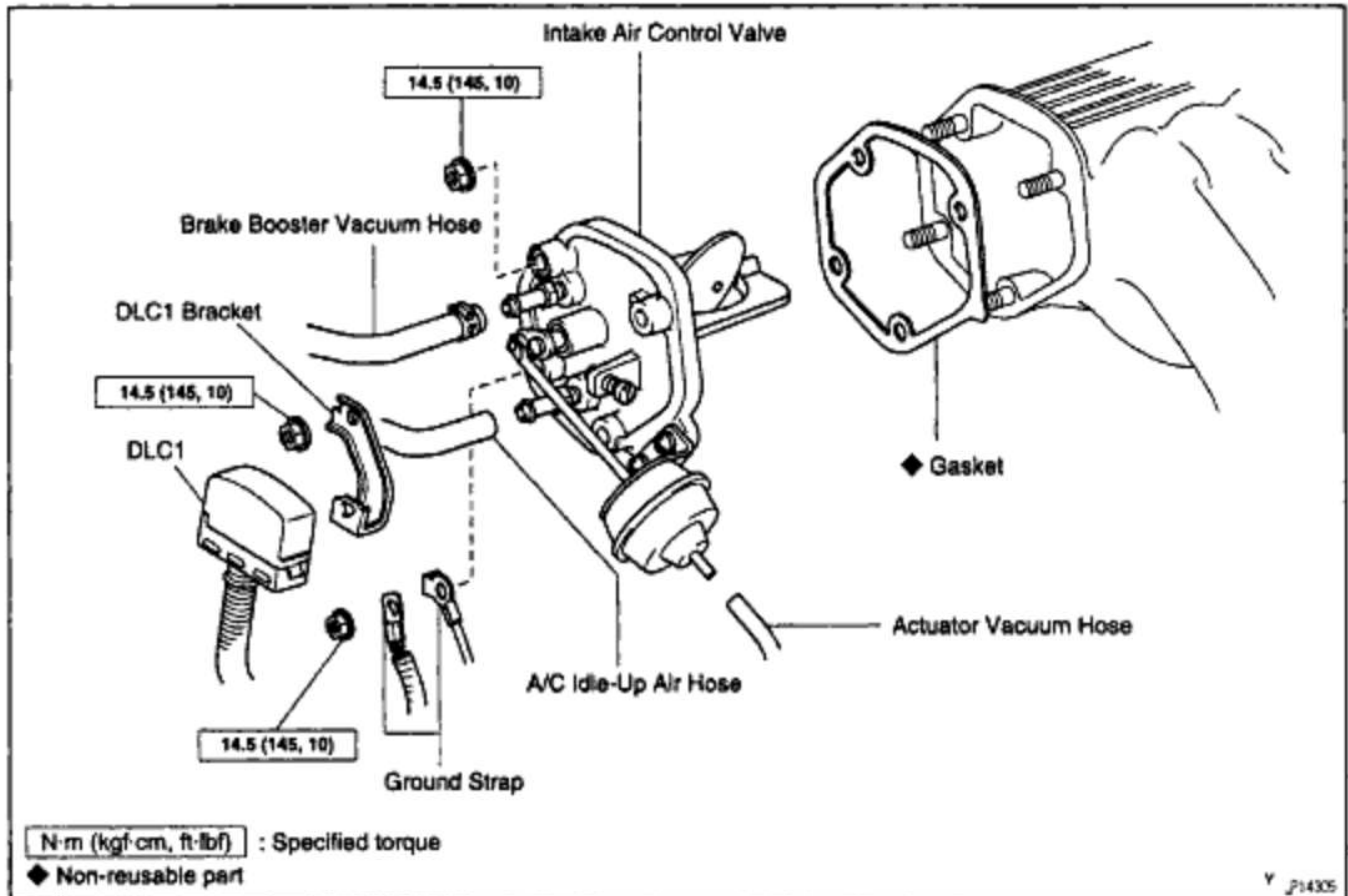

INTAKE AIR CONTROL VALVE REMOVAL

(See Components for Removal and Installation)

1. DISCONNECT NEGATIVE (-) TERMINAL CABLE FROM BATTERY

CAUTION: Work must be started after 90 seconds from the time the ignition switch is turned to the "LOCK" position and the negative (-) terminal cable is disconnected from the battery.

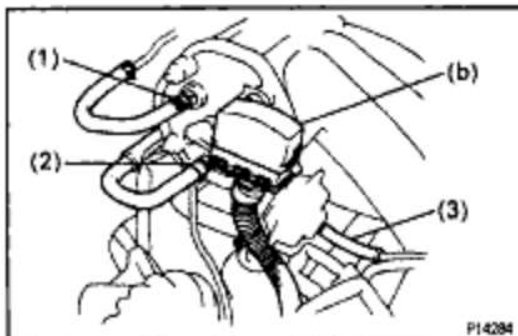

2. DISCONNECT HOSES FROM INTAKE AIR CONTROL VALVE

- (a) Disconnect the following hoses:
- (1) Brake booster vacuum hose
 - (2) A/C idle-up air hose
 - (3) Actuator vacuum hose
- (b) Disconnect the DLC1.

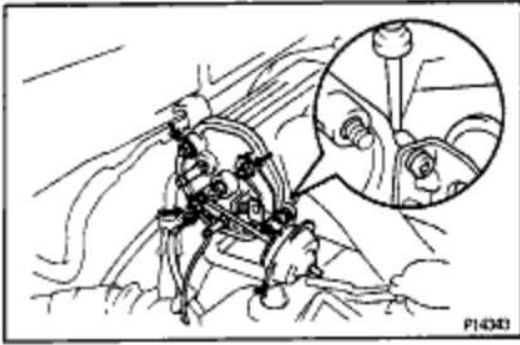

3. REMOVE INTAKE AIR CONTROL VALVE

- (a) Remove the 4 nuts and DLC1 bracket, and disconnect the 2 ground straps.
- (b) Remove the intake air control valve by prying a screwdriver between the intake air control valve and air intake chamber.
- (c) Remove the gasket.

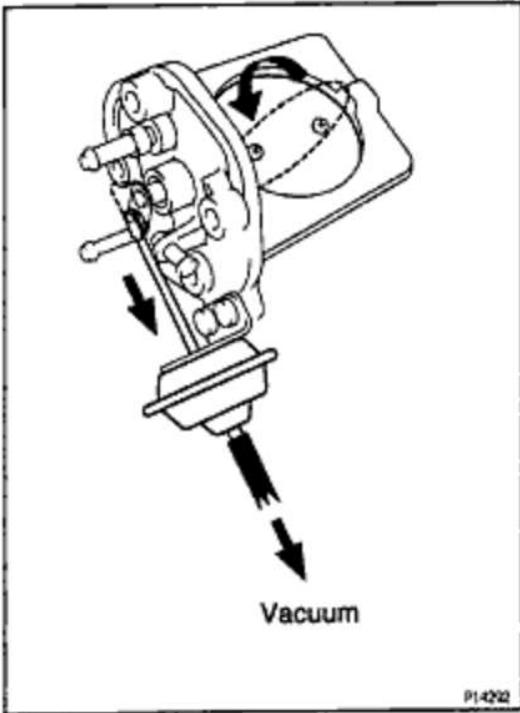

INTAKE AIR CONTROL VALVE AND COMPONENTS INSPECTION

1. INSPECT INTAKE AIR CONTROL VALVE

- (a) With 26.7 kPa (200 mmHg, 7.9 in.Hg) of vacuum applied to the actuator, check that the actuator rod moves.
 - (b) One minute after applying the vacuum in (a), check that the actuator rod does not return.
- If the operation is not as specified, replace the intake air control valve.

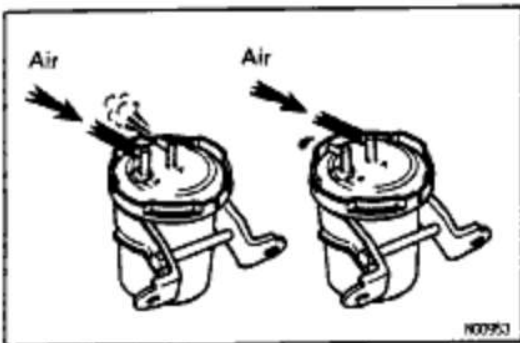

2. INSPECT VACUUM TANK

LOCATION: The LH side member under the battery tray.

- (a) Check that air flows from port B to port A.
- (b) Check that air does not flow from port A to port B.

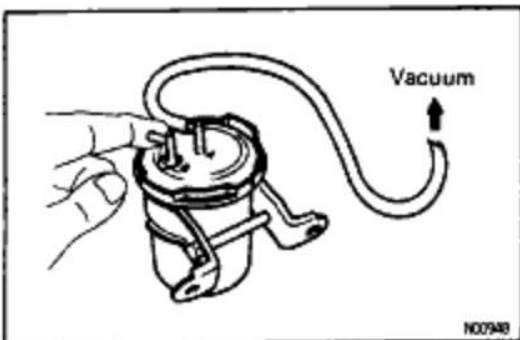

- (c) Plug port B with your finger, and apply 26.7 kPa (200 mmHg, 7.9 in.Hg) of vacuum to port A, and check that there is no change in vacuum after one minute.
- If the operation is not as specified, replace the vacuum tank.

3. INSPECT VSV

(See page [EG2-293](#))

EG2-278

1MZ-FE ENGINE - SFI SYSTEM

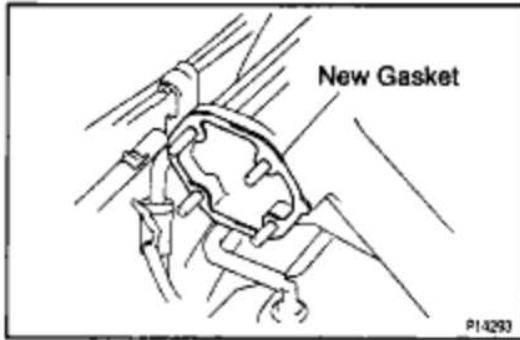

INTAKE AIR CONTROL VALVE INSTALLATION

(See Components for Removal and Installation)

1. INSTALL INTAKE AIR CONTROL VALVE

(a) Install a new gasket to the air intake chamber.

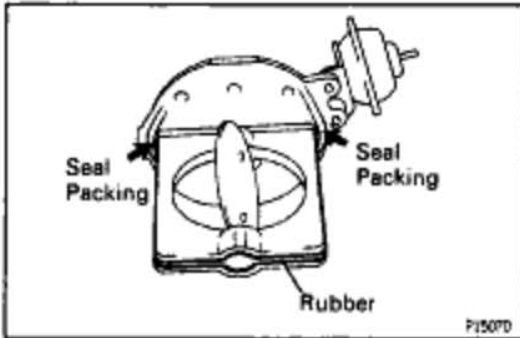

(b) Apply a light coat of engine oil to the rubber portions.

(c) Apply seal packing to the positions of the intake air control valve shown in the

Seal packing:

Part No.08826-00080 or equivalent illustration.

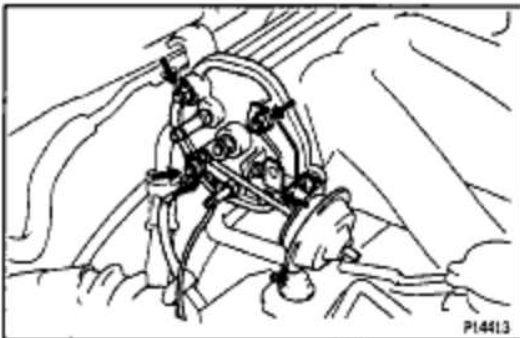

(d) Install the intake air control valve, DLC 1 bracket and 2 ground straps with the 4 nuts.

Torque: 14.5 N-m (145 kgf-cm, 10 ft-lbf)

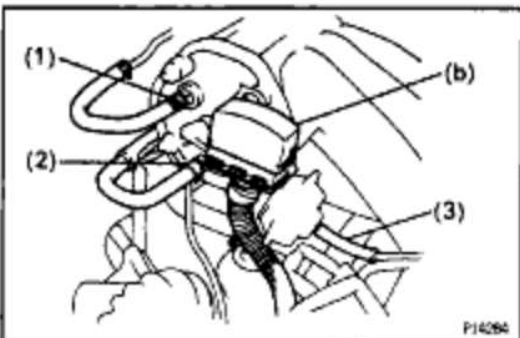

2. CONNECT HOSES TO INTAKE AIR CONTROL VALVE

(a) Connect the following hoses:

(1) Brake booster vacuum hose

(2) A/C idle-up air hose

(3) Actuator vacuum hose

(b) Install the DLC1.

3. CONNECT NEGATIVE (-) TERMINAL CABLE TO BATTERY

4. CHECK FOR FUEL LEAKAGE

(See page [EG2-228](#))

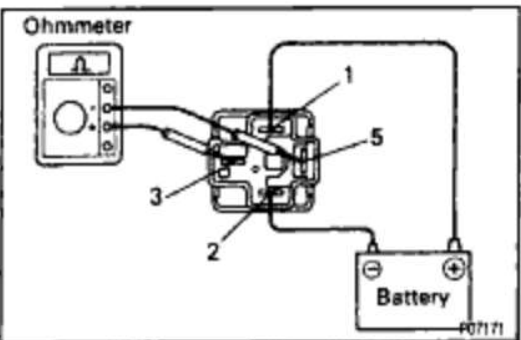
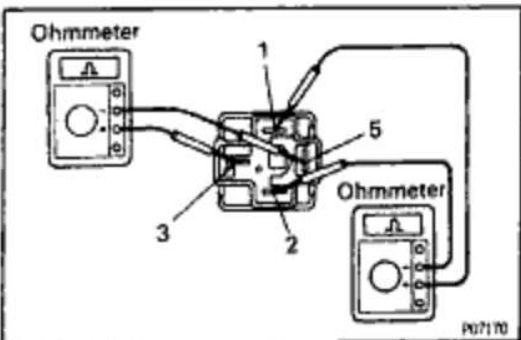
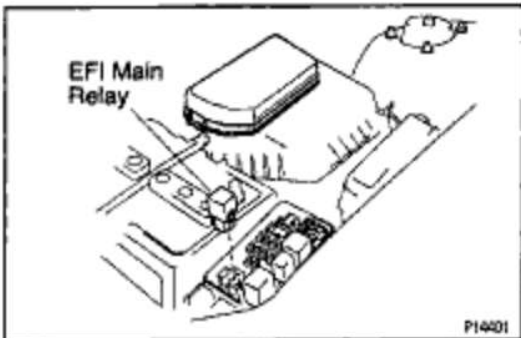
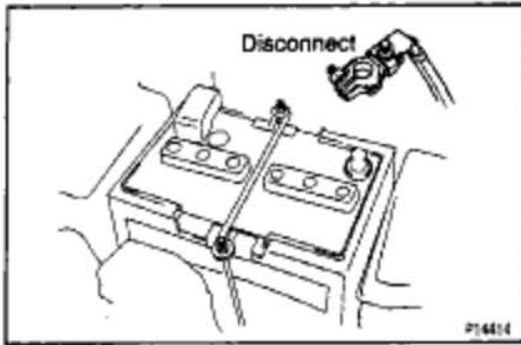

EFI MAIN RELAY

EFI MAIN RELAY INSPECTION

1. DISCONNECT NEGATIVE (-) TERMINAL CABLE FROM BATTERY

CAUTION: Work must be started after 90 seconds from the time the ignition switch is turned to the "LOCK" position and the negative (-) terminal cable is disconnected from the battery.

2. REMOVE EFI MAIN RELAY

LOCATION: In the engine compartment relay box.

3. INSPECT EFI MAIN RELAY

A. Inspect relay continuity

(a) Using an ohmmeter, check that there is continuity between terminals 1 and 2.

(b) Check that there is no continuity between terminals 3 and 5.

If continuity is not as specified, replace the relay.

B. Inspect relay operation

(a) Apply battery voltage across terminals 1 and 2.

(b) Using an ohmmeter, check that there is continuity between terminals 3 and 5.

If operation is not as specified, replace the relay.

4. REINSTALL EFI MAIN RELAY

5. RECONNECT NEGATIVE (-) TERMINAL CABLE TO BATTERY

EG2-280

1MZ-FE ENGINE - SFI SYSTEM

CIRCUIT OPENING RELAY COMPONENTS FOR REMOVAL AND NOW INSTALLATION

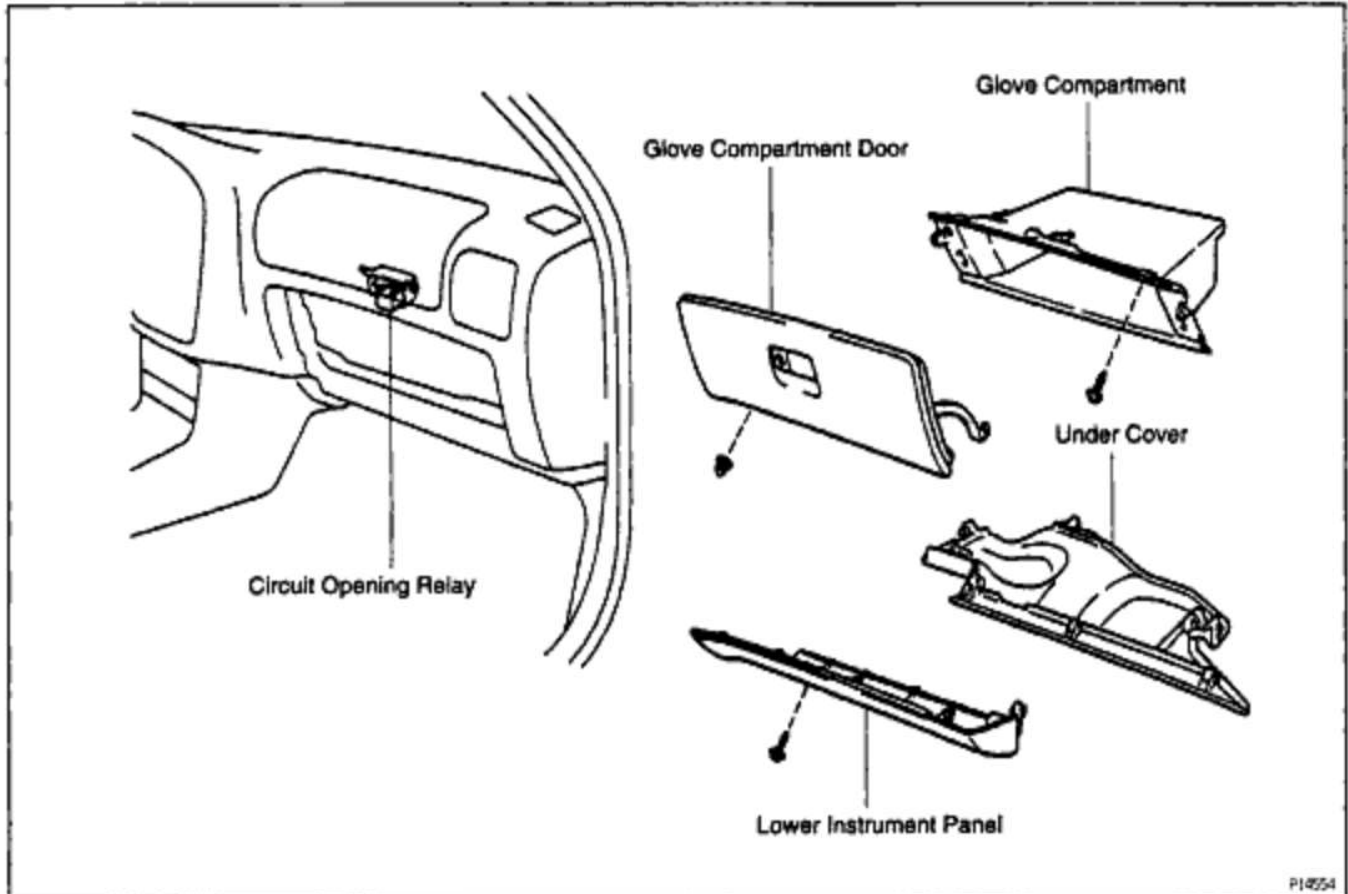

P14554

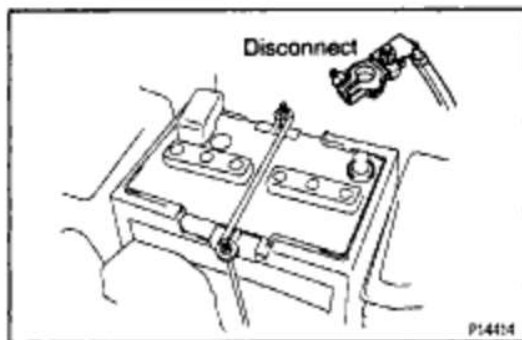

P14414

CIRCUIT OPENING RELAY INSPECTION

(See Components for Removal and Installation)

1. DISCONNECT NEGATIVE (-) TERMINAL CABLE FROM BATTERY

CAUTION: Work must be started after 90 seconds from the time the ignition switch is turned to the 'LOCK' position and the negative (-) terminal cable is disconnected from the battery.

2. REMOVE CIRCUIT OPENING RELAY

3. INSPECT CIRCUIT OPENING RELAY

A. Inspect relay continuity

(a) Using an ohmmeter, check that there is continuity between terminals ST and E1.

(b) Check that there is continuity between terminals +B and FC.

(c) Check that there is no continuity between terminals +B and FP.

If continuity is not as specified, replace the relay.

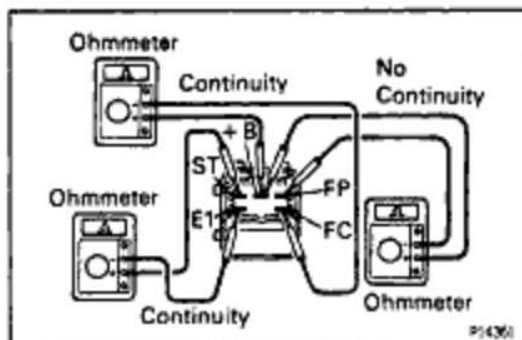

P14360

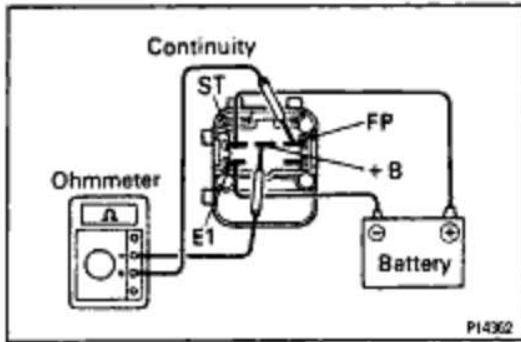

B. Inspect relay operation

(a) Apply battery voltage across terminals ST and E1.
 M Using an ohmmeter, check that there is continuity between terminals +B and FP.

If operation is not as specified, replace the relay.

4. REINSTALL CIRCUIT OPENING RELAY

5. RECONNECT NEGATIVE (-) TERMINAL CABLE TO BATTERY

EG2-282

1MZ-FE ENGINE - SFI SYSTEM

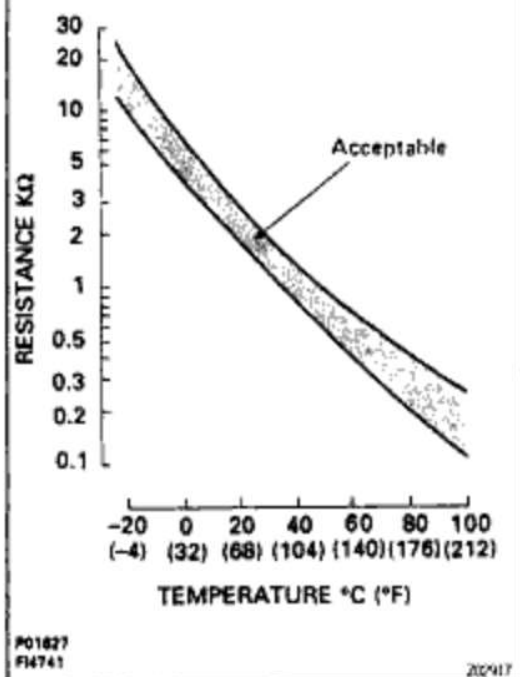
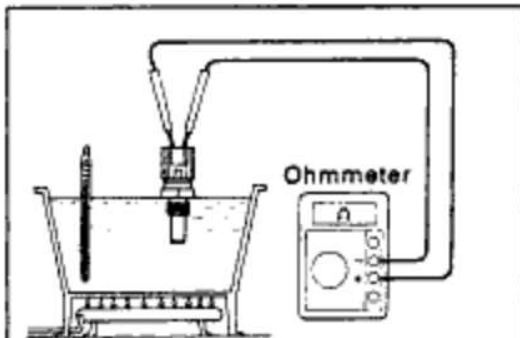
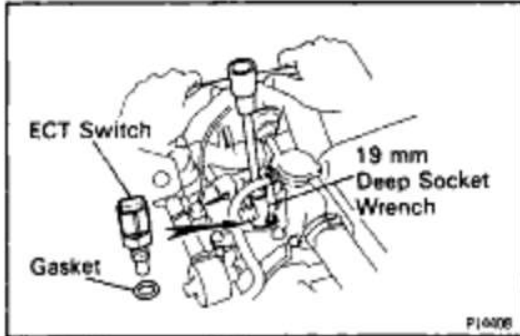
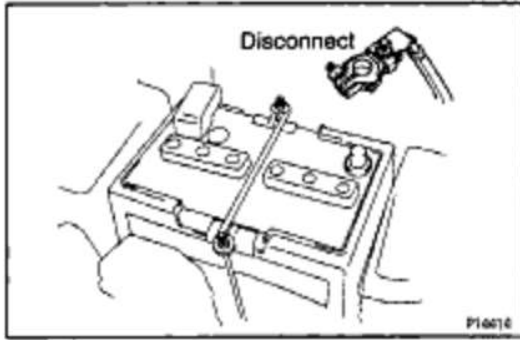

ENGINE COOLANT TEMPERATURE (ECT) SENSOR

ECT SENSOR INSPECTION

1. DISCONNECT NEGATIVE (-) TERMINAL CABLE FROM BATTERY

CAUTION: Work must be started after 90 seconds from the time the ignition switch is turned to the "LOCK" position and the negative (-) terminal cable is disconnected from the battery.

2. DRAIN ENGINE COOLANT

3. REMOVE ECT SENSOR

(a) Disconnect the ECT sensor connector.

(b) Using a 19 mm deep socket wrench, remove the ECT sensor and gasket.

4. INSPECT ECT SENSOR

Using an ohmmeter, measure the resistance between the terminals.

Resistance:

Refer to the graph

If the resistance is not as specified, replace the ECT sensor.

5. REINSTALL ECT SENSOR

(a) Install a new gasket to the ECT sensor.

(b) Using a 19 mm deep socket, install the ECT sensor.

Torque: 20 N-m (200 kgf-cm, 14 ft-lbf)

(c) Connect the ECT sensor connector.

6. REFILL WITH ENGINE COOLANT

Capacity:

8.7 liters (9.2 US qts, 7.7 Imp. qts)

7. RECONNECT NEGATIVE (-) TERMINAL CABLE TO BATTERY

VSV FOR FUEL PRESSURE CONTROL

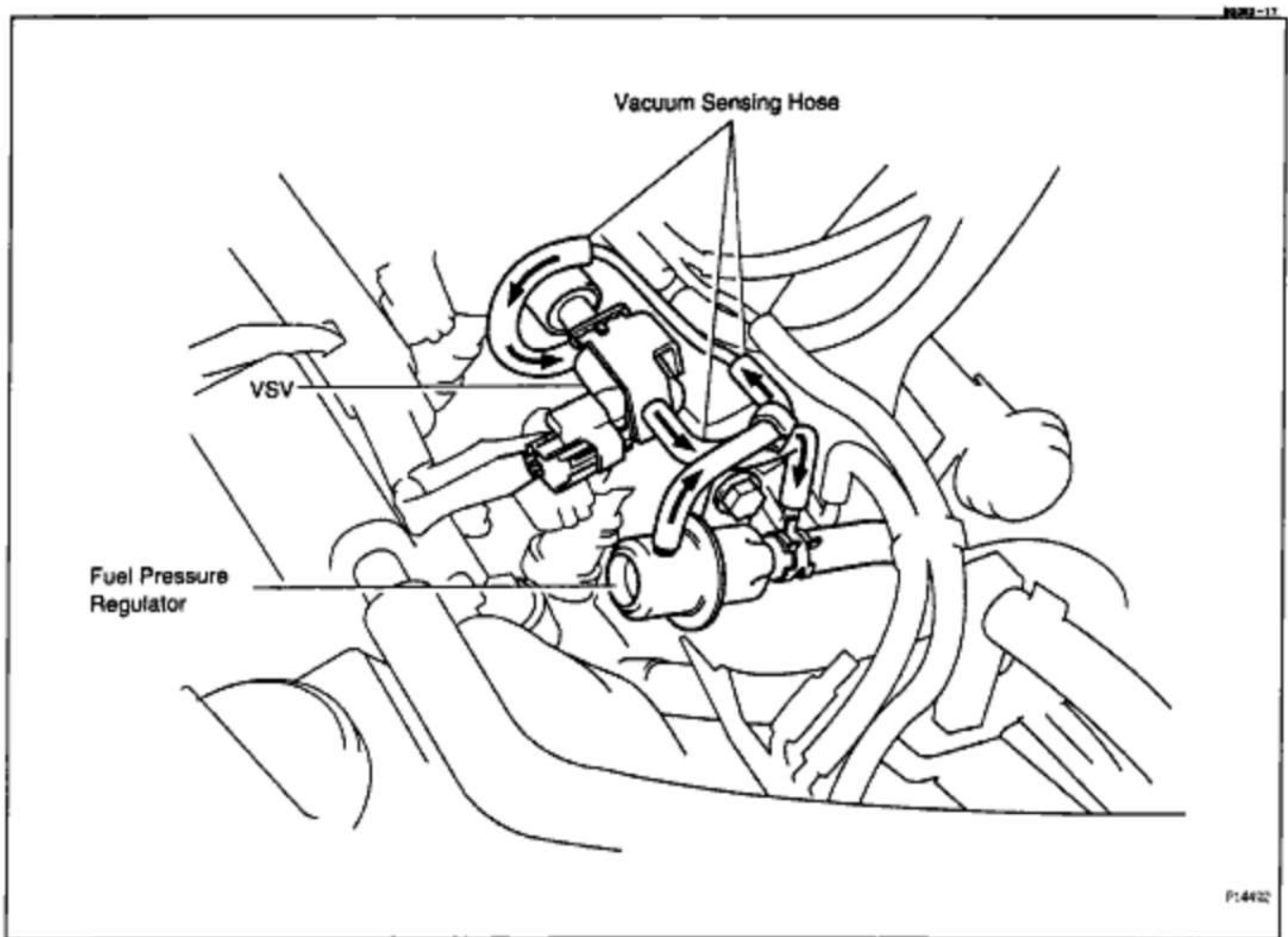

ON-VEHICLE INSPECTION

CHECK FUEL PRESSURE
(See step 2 on page [EG2-231](#))

COMPONENTS FOR REMOVAL AND INSTALLATION

83462-10

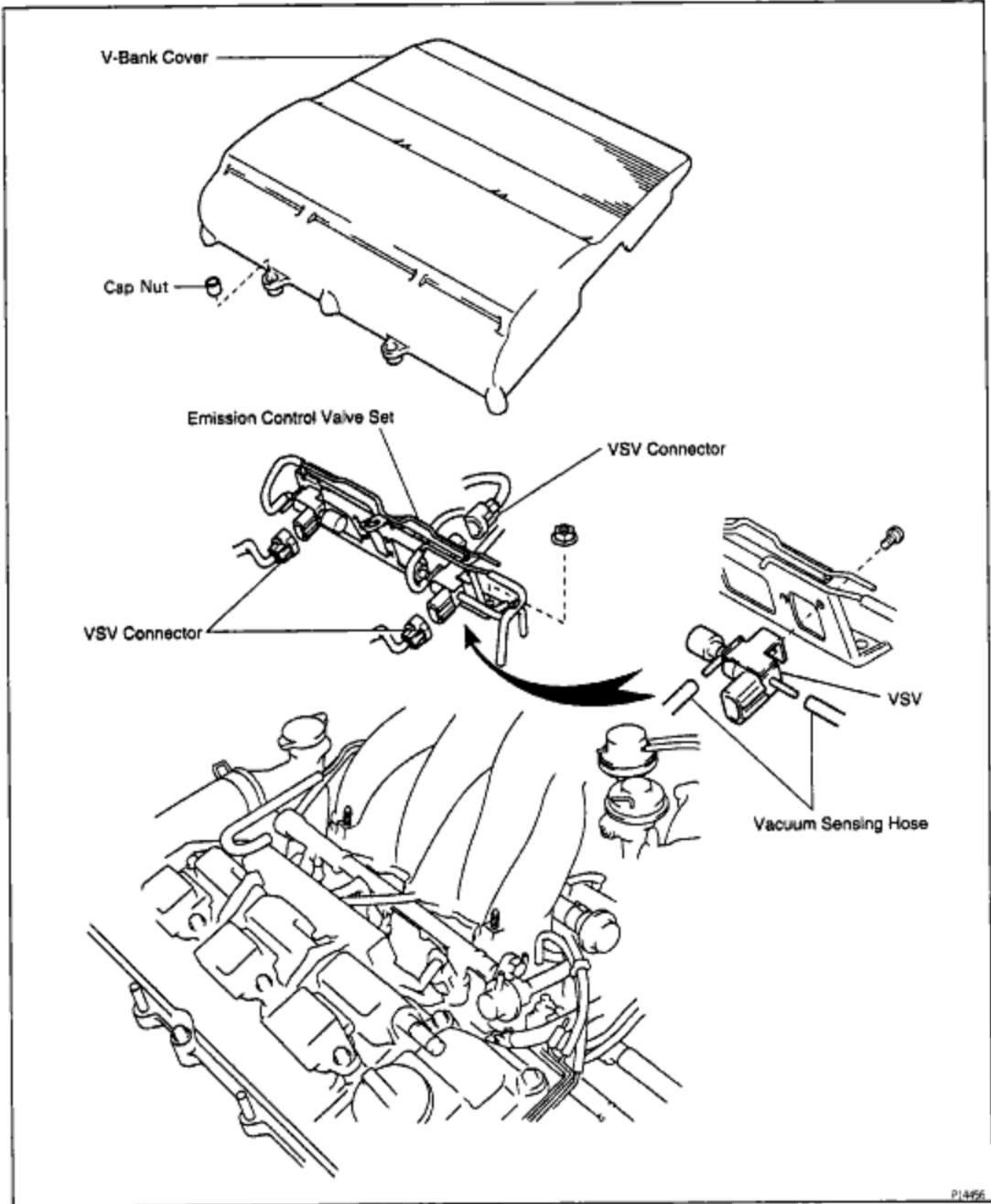

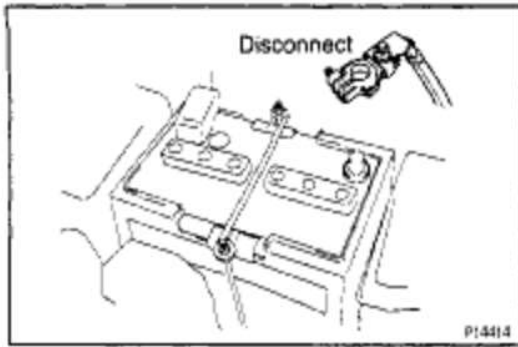

VSV INSPECTION

(See Components for Removal and Installation)

1. DISCONNECT NEGATIVE (-) TERMINAL CABLE FROM BATTERY

CAUTION: Work must be started after 90 seconds from the time the ignition switch is turned to the 'LOCK' position and the negative (-) terminal cable is disconnected from the battery.

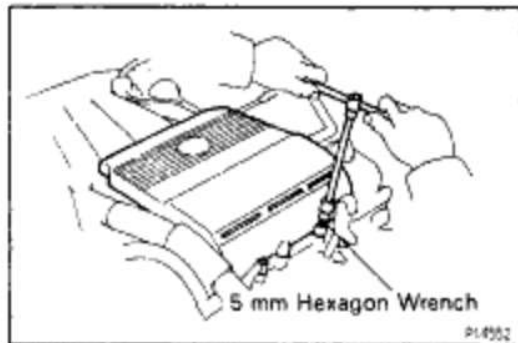

2. REMOVE V-BANK COVER

Using a 5 mm hexagon wrench, remove the 2 cap nuts and V-bank cover.

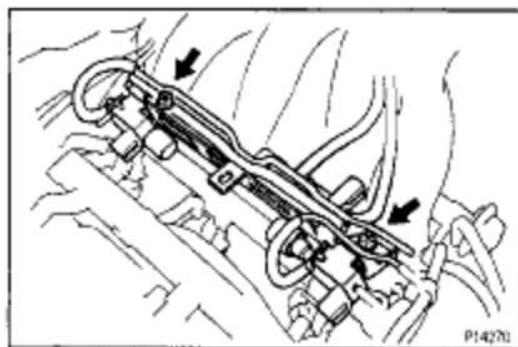

3. REMOVE EMISSION CONTROL VALVE SET

(See step 7 on page [EG2-246](#))

4. REMOVE VSV

- (a) Disconnect the 2 vacuum sensing hoses from the VSV.
- (b) Remove the screw and VSV.

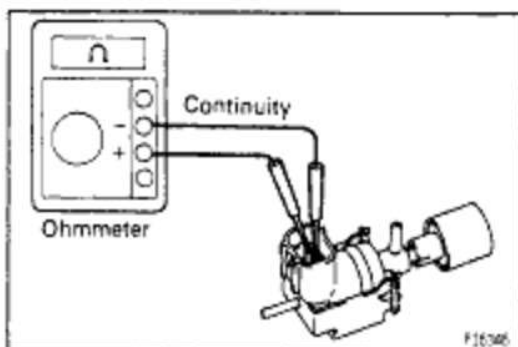

5. INSPECT VSV

A. Inspect VSV for open circuit

Using an ohmmeter, check that there is continuity between the terminals.

Resistance:

33 – 39 Ω at 20₂C (68₂ F)

If there is no continuity, replace the VSV.

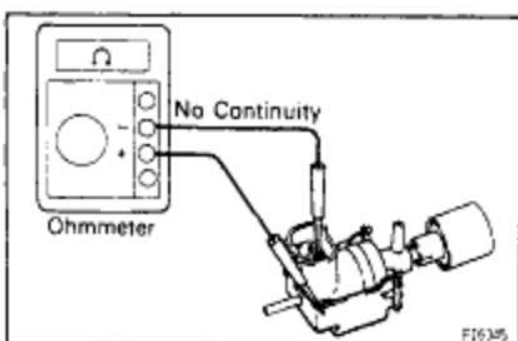

B. Inspect VSV for ground

Using an ohmmeter, check that there is no continuity between each terminal and the body.

If there is continuity, replace the VSV.

EG2-286

1MZ-FE ENGINE – FE ENGINE – SFI SYSTEM

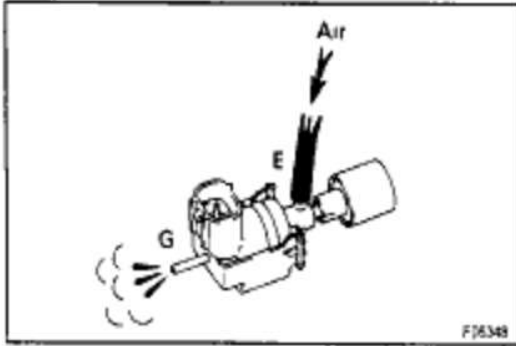
**C. Inspect VSV operation**

(a) Check that the air flows from ports E to G.

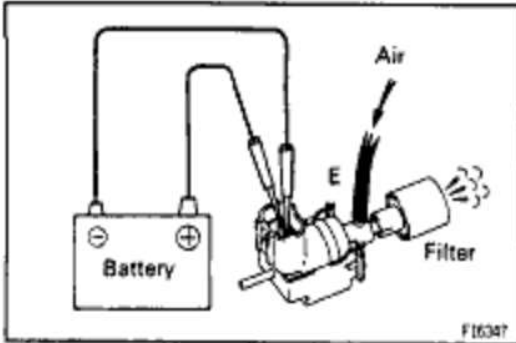

(b) Apply battery voltage across the terminals.

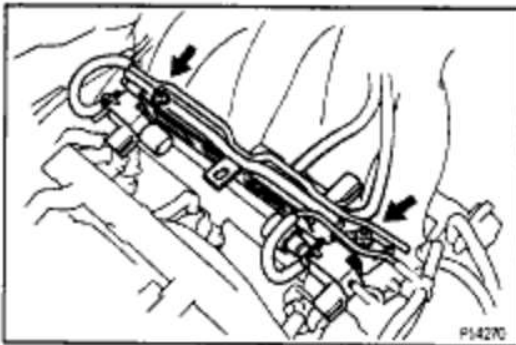
(c) Check that the air flows from port E to the filter.
If operation is not as specified, replace the VSV.**6. REINSTALL EMISSION CONTROL VALVE SET**(See step 8 on page [EG2-256](#))**7. REINSTALL VSV**

(a) Install the VSV with the screw.

(b) Connect the 2 vacuum sensing hoses to the VSV.

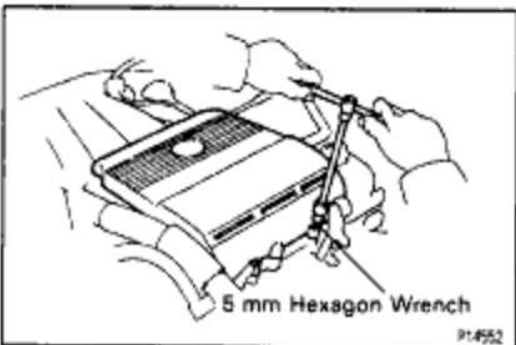
**8. REINSTALL V-BANK COVER**

Using a 5 mm hexagon wrench, install the V-bank cover with the 2 cap nuts.

HINT: For fixing the V-bank cover, push on the cover until sense of "click" is felt.

9. RECONNECT NEGATIVE (-) TERMINAL CABLE TO BATTERY

VSV FOR EGR

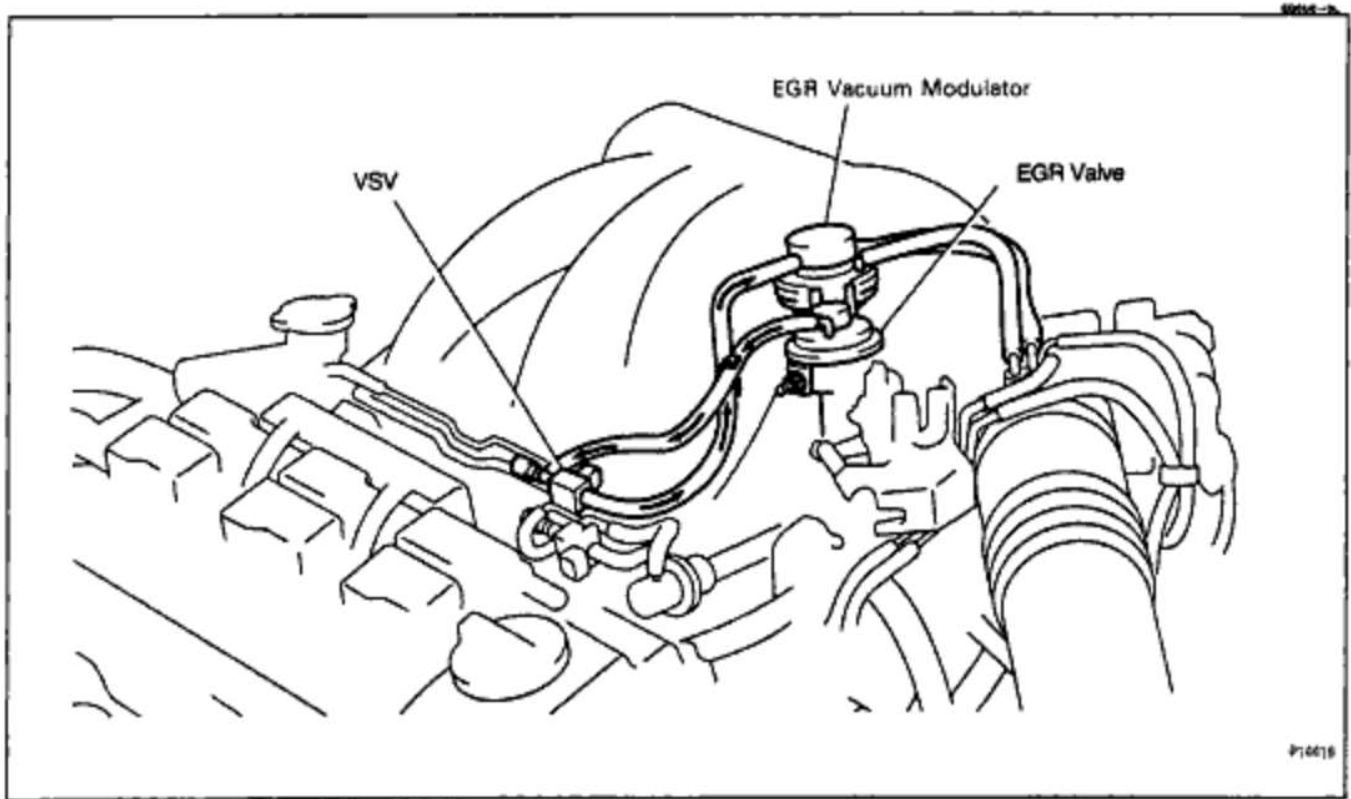

ON-VEHICLE INSPECTION

EGR SYSTEM INSPECTION

(See steps 2 to 6 on pages [EG2-207](#) and 208)

COMPONENTS FOR REMOVAL AND INSTALLATION

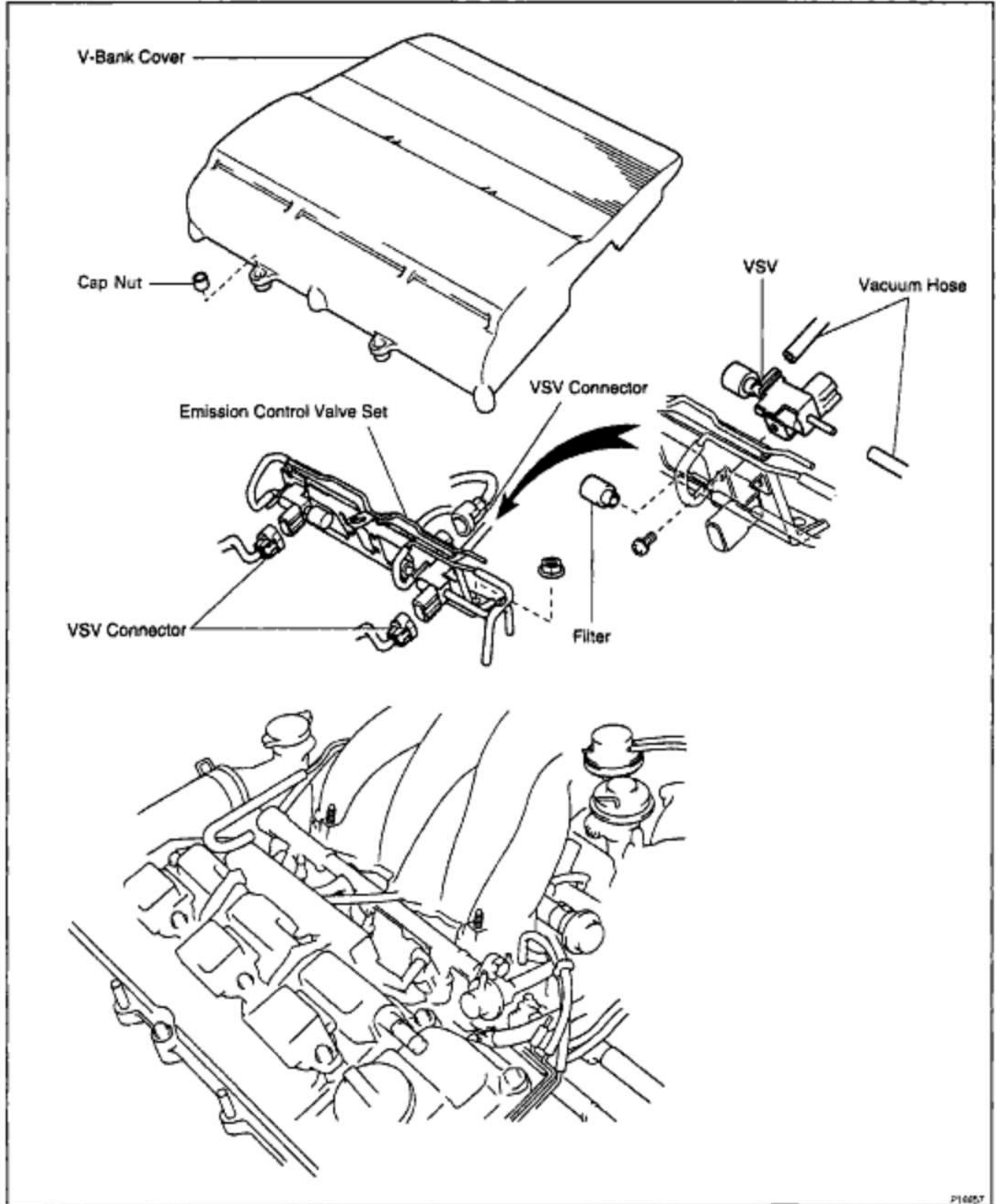

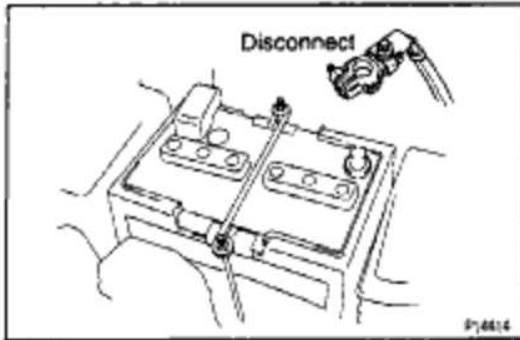

VSV INSPECTION

(See Components for Removal and Installation)

1. DISCONNECT NEGATIVE (-) TERMINAL CABLE FROM BATTERY

CAUTION: Work must be started after 90 seconds from the time the Ignition switch is turned to the "LOCK" position and the negative (-) terminal cable is disconnected from the battery.

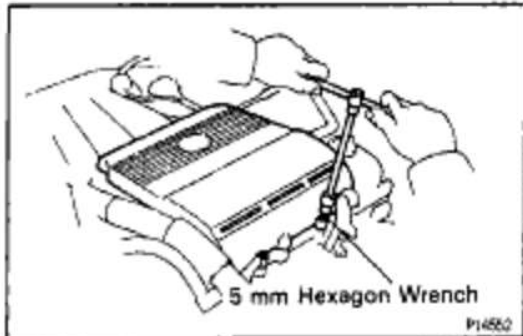

2. REMOVE V-BANK COVER

Using a 5 mm hexagon wrench, remove the 2 cap nuts and V - bank cover.

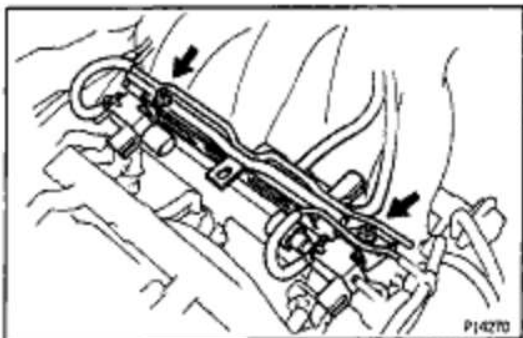

3. REMOVE EMISSION CONTROL VALVE SET

(See step 7 on page [EG2-246](#))

4. REMOVE VSV

- Remove the filter.
- Disconnect the 2 vacuum hoses from the VSV.
- Remove the screw and VSV.

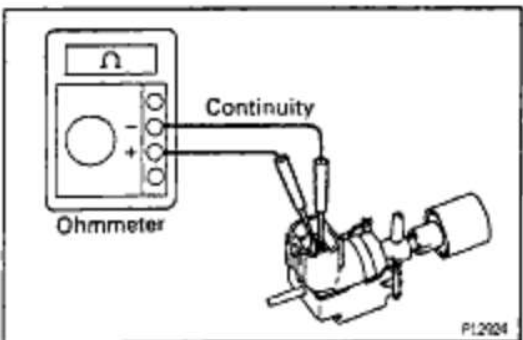

5. INSPECT VSV

A. Inspect VSV for open circuit

Using an ohmmeter, check that there is continuity between the terminals.

Resistance:

33 - 39 at 20° C (68° F)

If there is no continuity, replace the VSV.

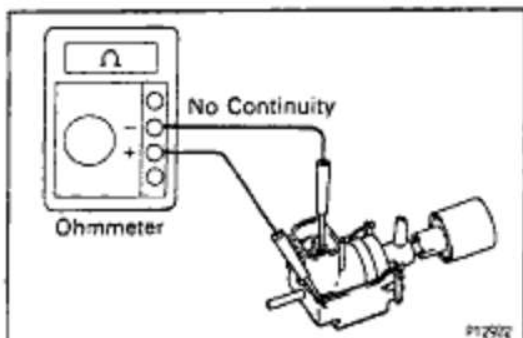

B. Inspect VSV for ground

Using an ohmmeter, check that there is no continuity between each terminal and the body.

If there is continuity, replace the VSV.

1MZ-FE ENGINE –

-Memo

VSV FOR ACIS

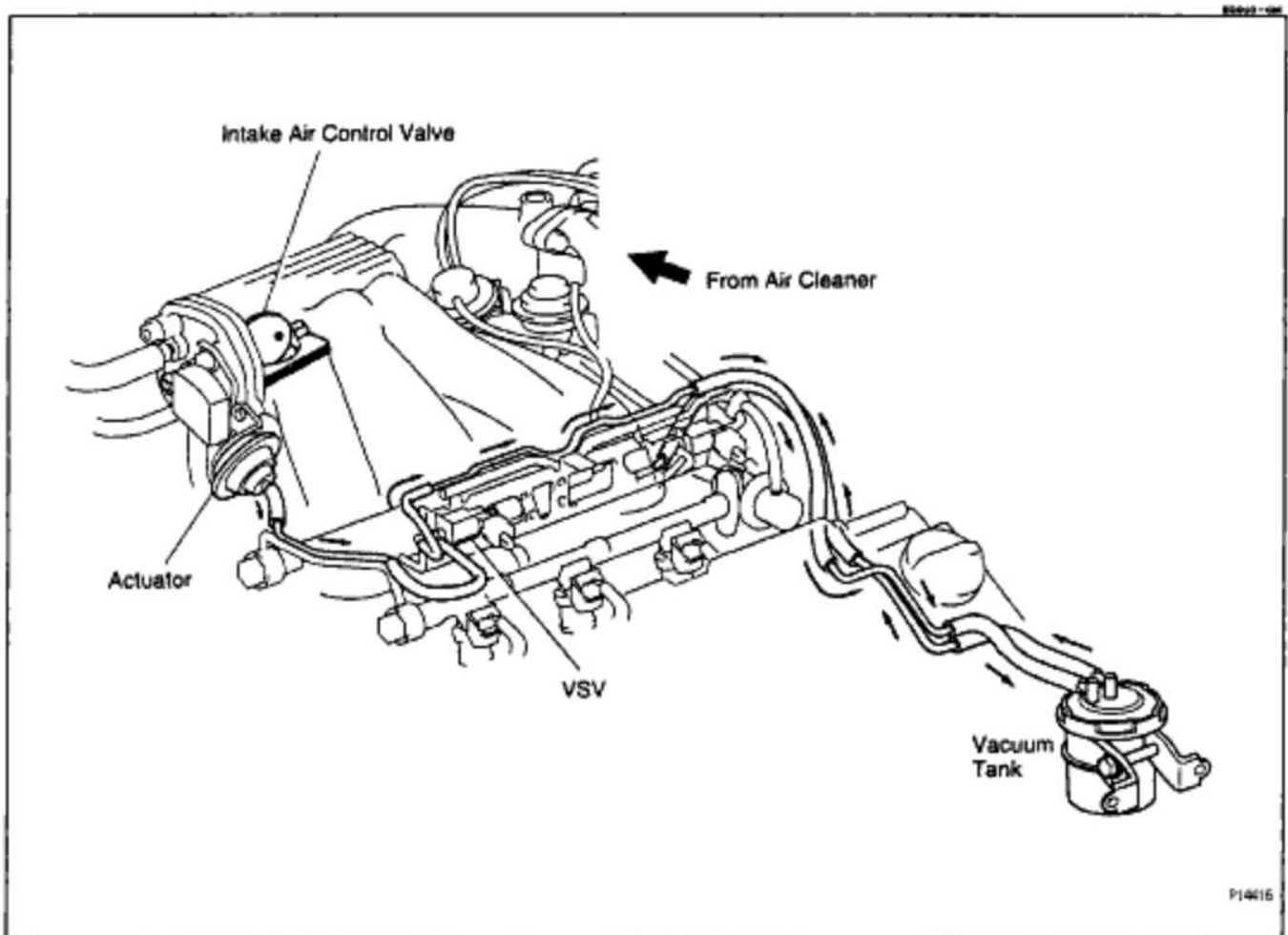

ON-VEHICLE INSPECTION
INSPECT INTAKE AIR CONTROL VALVE
(See page [EG2-275](#))

COMPONENTS FOR REMOVAL AND INSTALLATION

89882-1A

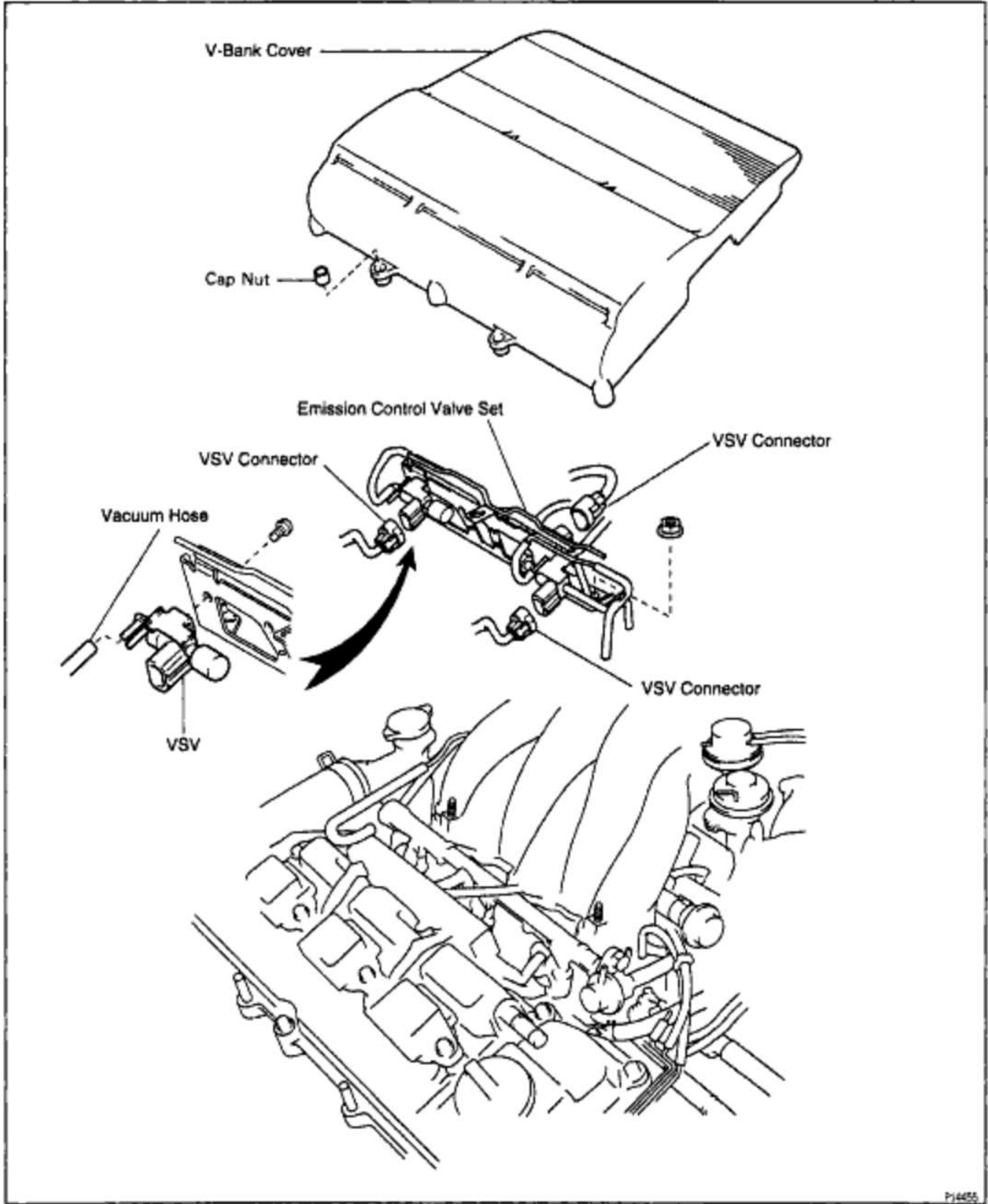

PJ4455

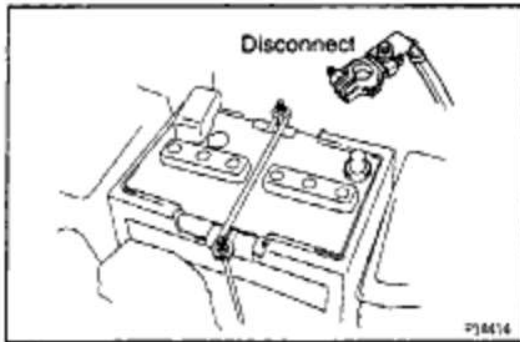

VSV INSPECTION

(See Components for Removal and Installation)

1. DISCONNECT NEGATIVE (-) TERMINAL CABLE FROM BATTERY

CAUTION: Work must be started after 90 seconds from the time the ignition switch is turned to the "LOCK" position and the negative (-) terminal cable is disconnected from the battery.

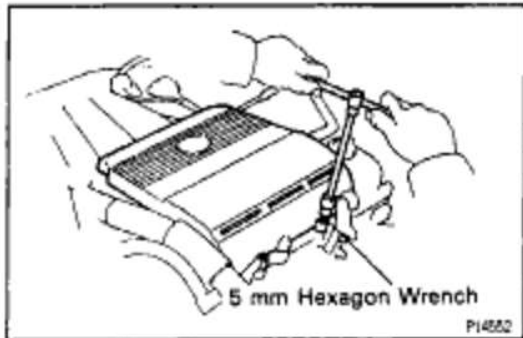

2. REMOVE V - BANK COVER

Using a 5 mm hexagon wrench, remove the 2 cap nuts and V-bank cover.

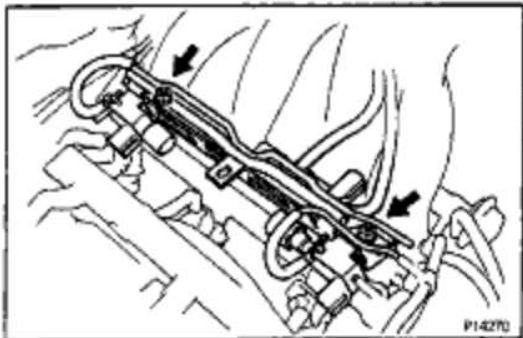

3. REMOVE EMISSION CONTROL VALVE SET

(See step 7 on page [EG2-246](#))

4. REMOVE VSV

- Disconnect the 2 vacuum hoses from the VSV.
- Remove the screw and VSV.

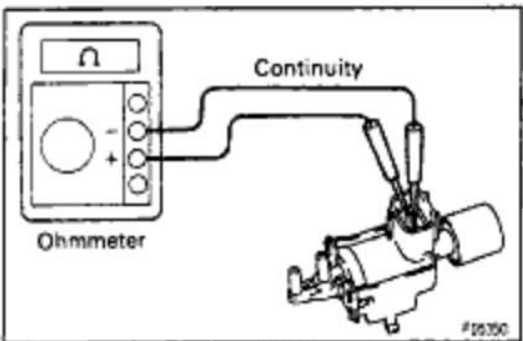

5. INSPECT VSV

A. Inspect VSV for open circuit

Using an ohmmeter, check that there is continuity between each terminals.

Resistance:

33 – 39 Ω at 20°C (68°F)

If there is no continuity, replace the VSV.

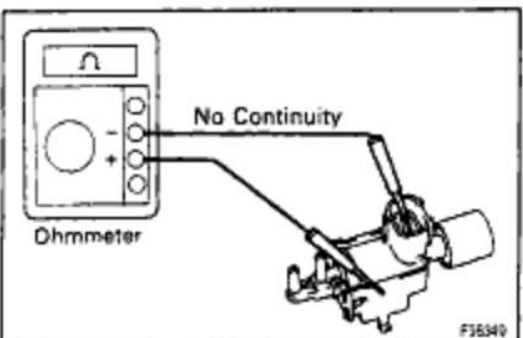

B. Inspect VSV for ground

Using an ohmmeter, check that there is no continuity between each terminal and the body.

If there is continuity, replace the VSV.

EG2-294

1MZ-FE ENGINE - SFI SYSTEM

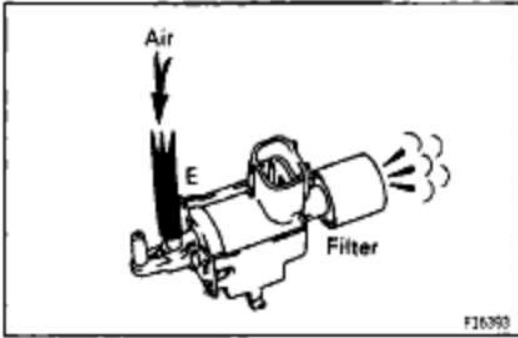
**C. Inspect VSV operation**

(a) Check that air flows from pipe E to the filter.

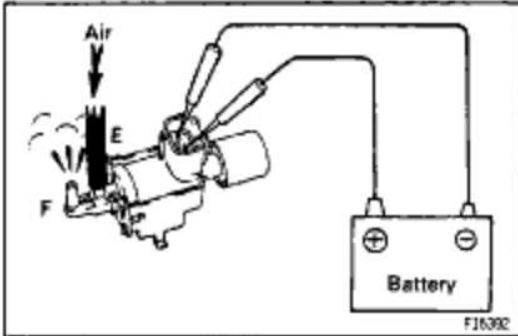

(b) Apply battery voltage across the terminals.

(c) Check that air flows from pipe E to pipe F.

If operation is not as specified, replace the VSV.

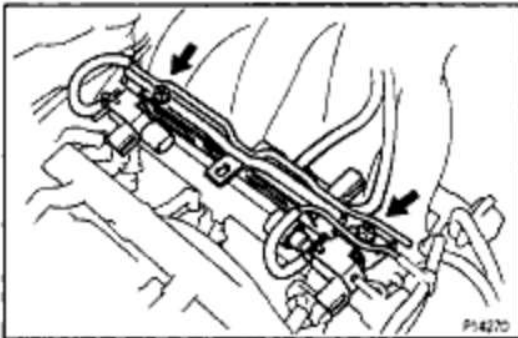
**6. REINSTALL EMISSION CONTROL VALVE SET**

(See step 8 on page [EG2-256](#))

7. REINSTALL VSV

(a) Install the VSV with the screw.

(b) Connect the 2 vacuum to the VSV.

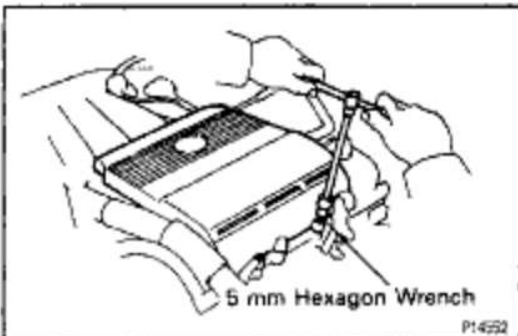
**8. REINSTALL V-BANK COVER**

Using a 5 mm hexagon wrench, install the V – bank cover with the 2 cap nuts.

HINT: For fixing the V-bank cover, push on the cover until sense of "click" is felt.

9. RECONNECT NEGATIVE (-) TERMINAL CABLE TO BATTERY

AC IDLE-UP VALVE

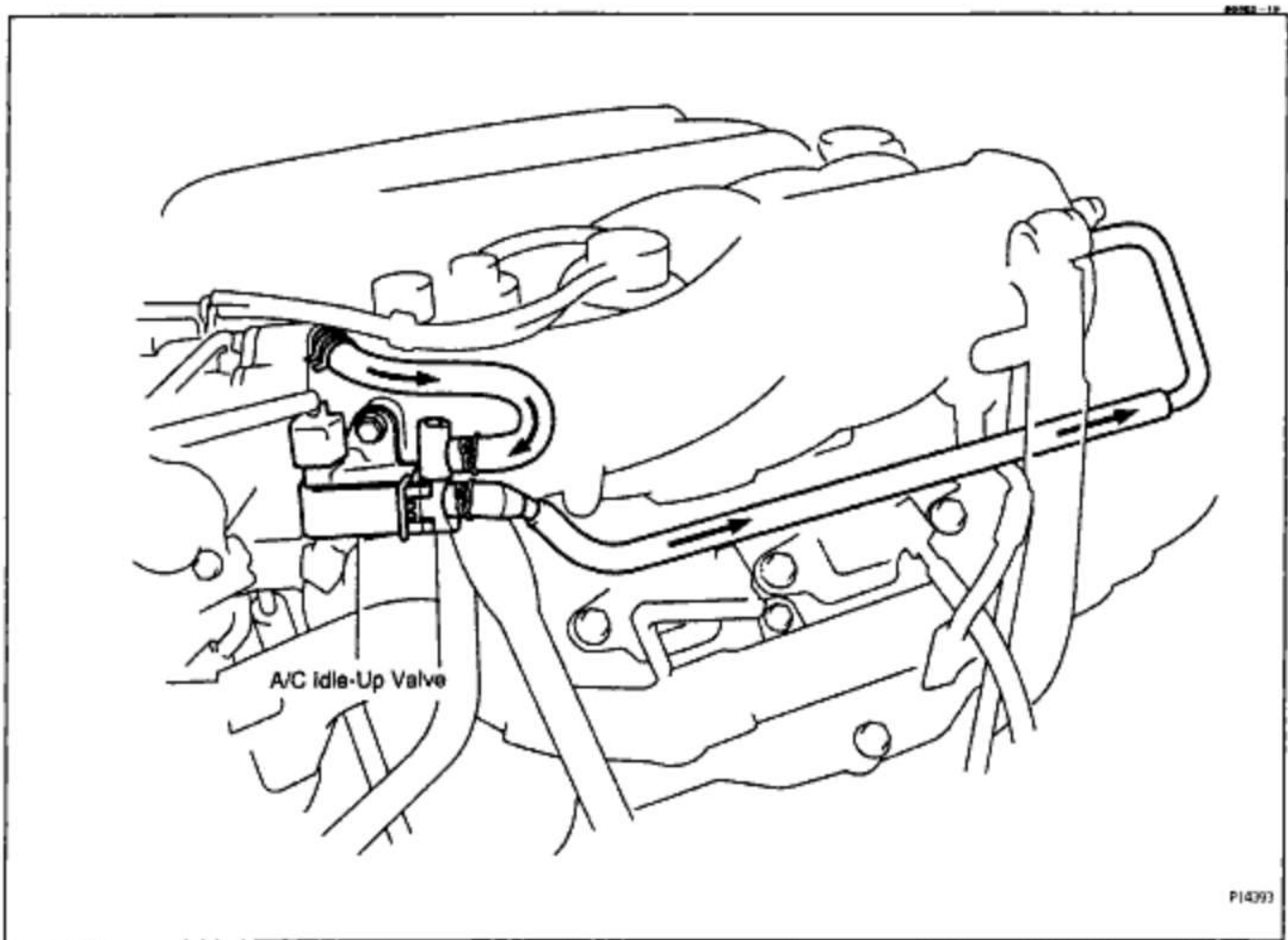

ON-VEHICLE INSPECTION INSPECT A/C IDLE-UP VALVE OPERATION

(a) Initial conditions:

- Engine at normal operating temperature
- Idle speed set correctly
- Transmission in neutral position
- A/C switch ON

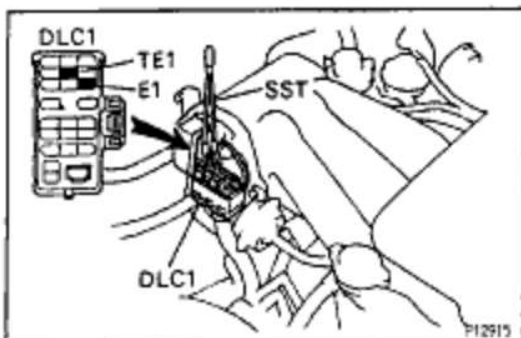

(b) Using SST, connect terminals TE1 and E1 of the DLC 1, check that idle-up occurs for approx. 3 seconds. SST 09843-18020

Valve operation is faulty if during the idle-up period the engine speed drops by 100 rpm or more, rough idle occurs, or the engine stalls.

(c) Observe the idle speed for approx. 3 to 15 seconds. During this time the idle -up valve should go off, the IAC valve half -open and idle -up should occur.

EG2-296

1MZ-FE ENGINE - FE ENGINE - SFI SYSTEM

- (d) Check that the idle speed after approx. 15 seconds, does not vary greatly from the idle speed observed in step
- (c). The idle-up valve should now be in ON position.

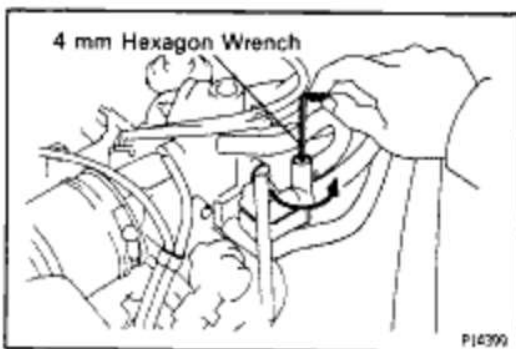
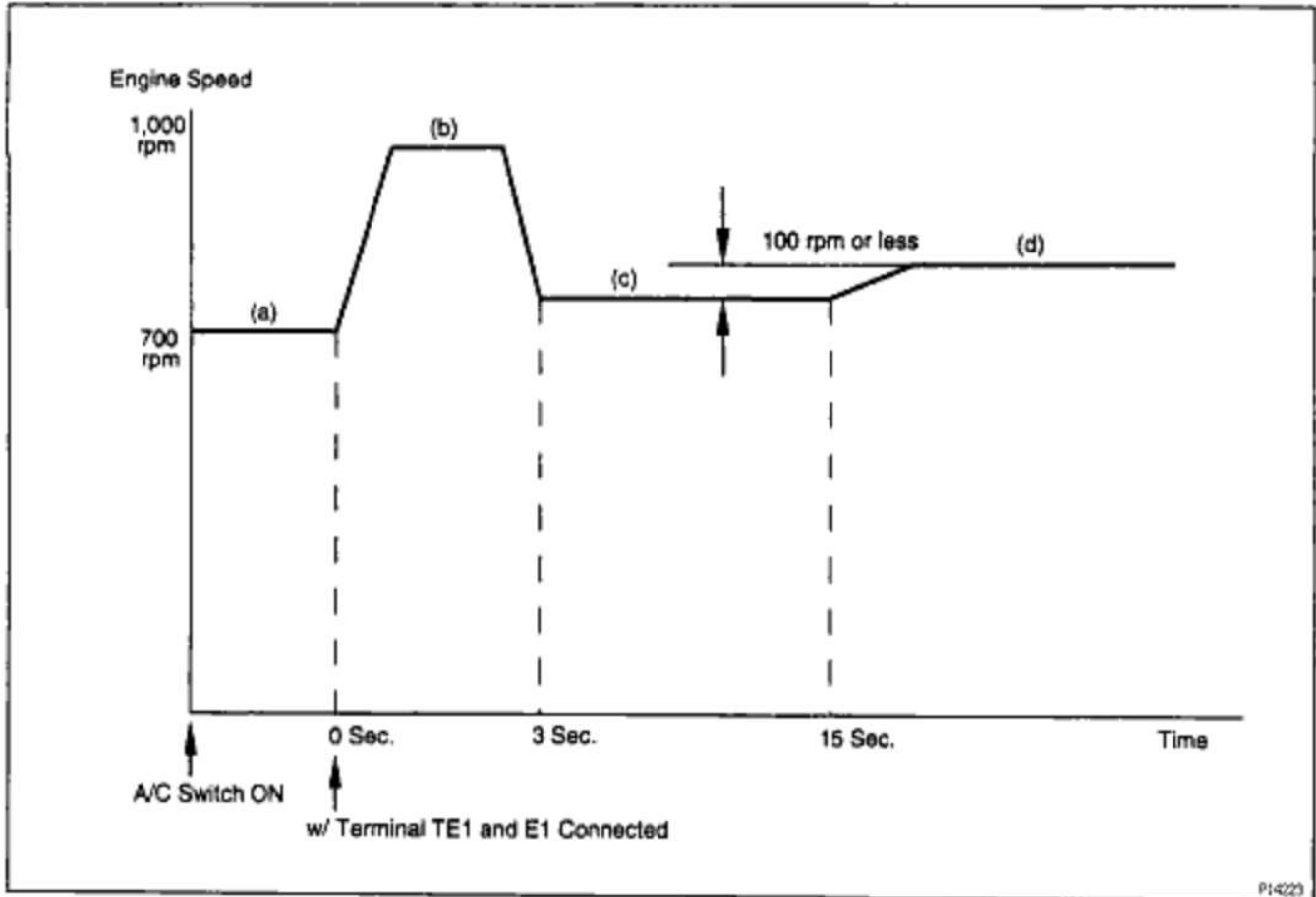

If the idle speed is increases by more 100 rpm, using a 4 mm hexagon wrench, turn the idle-up valve adjustment screw to correct the idle-up valve.

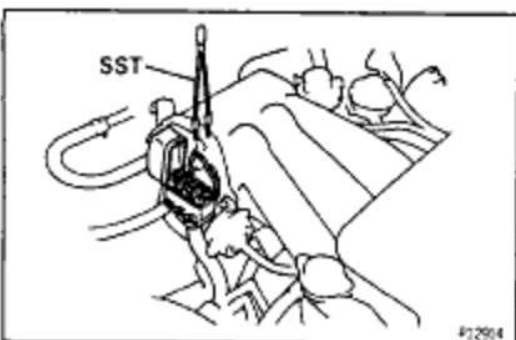

- (e) Remove the SST from the DLC1.
SST 09843-18020
- (f) A/C switch OFF.

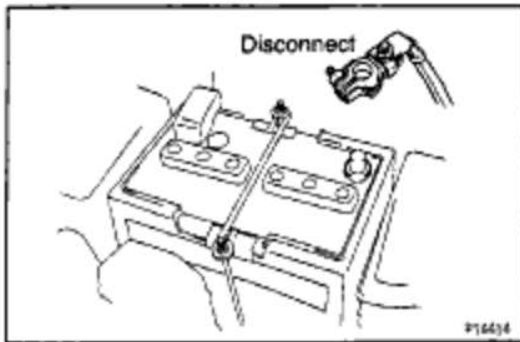

A/C IDLE-UP VALVE INSPECTION

1. DISCONNECT NEGATIVE (-) TERMINAL CABLE FROM BATTERY

CAUTION: Work must be started after 90 seconds from the time the ignition switch is turned to the "LOCK" position and the negative (-) terminal cable is disconnected from the battery.

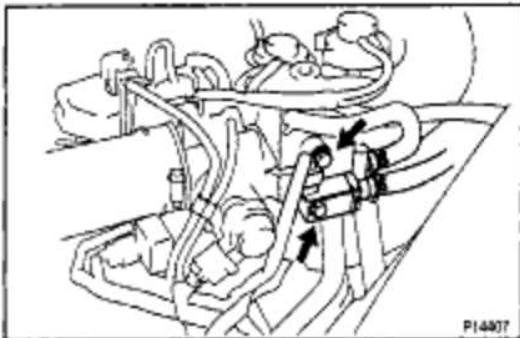

2. REMOVE A/C IDLE-UP VALVE

- Disconnect the idle-up valve connector.
- Disconnect the 2 air hoses.
- Remove the 2 bolts and idle-up valve.

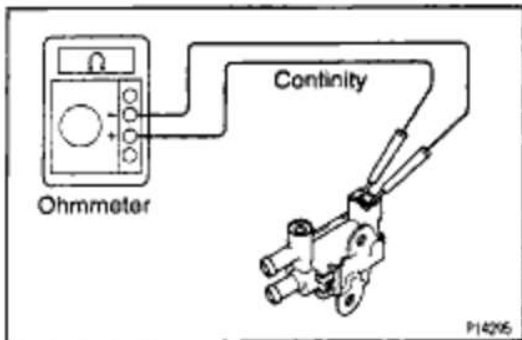

3. INSPECT A/C IDLE-UP VALVE

A. Inspect idle-up valve for open circuit

Using an ohmmeter, check that there is continuity between the terminals.

Resistance:

30 – 33 Ω at 20°C (68°F)

If there is no continuity, replace the idle-up valve.

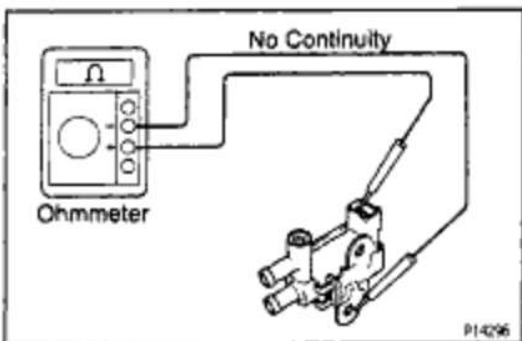

B. Inspect A/C idle-up valve for ground

Using an ohmmeter, check that there is no continuity between each terminal and the body.

If there is continuity, replace the idle-up valve.

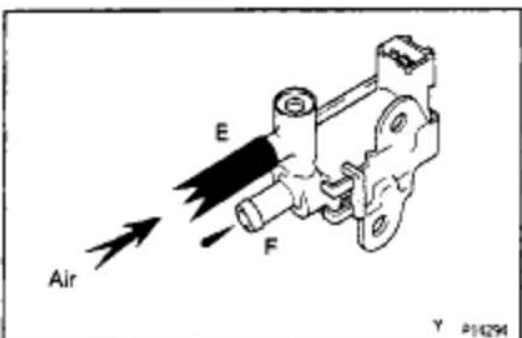

C. Inspect A/C idle-up valve operation

- Check that the air does not flow from port E to port F.

EG2-298

1MZ-FE ENGINE - SFI SYSTEM

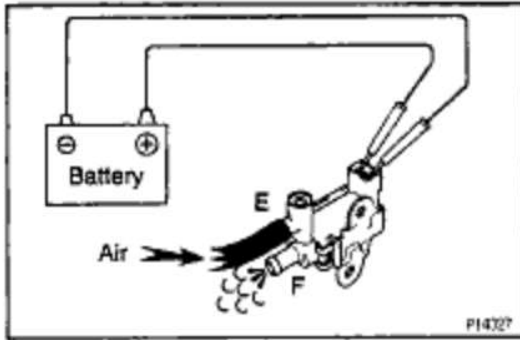

- (b) Apply battery voltage across the terminals.
- (c) Check that the air flows from port E to port F. If operation is not as specified, replace the idle-up valve.

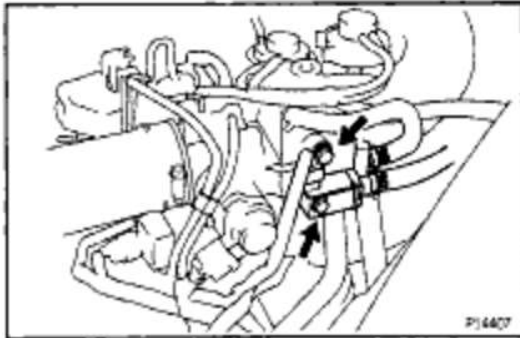
**4. REINSTALL A/C IDLE-UP VALVE**

- (a) Install the idle-up valve with the 2 bolts.
- (b) Connect the air hose.
- (c) Connect the idle-valve connector.

5. RECONNECT NEGATIVE (-) TERMINAL CABLE TO BATTERY

KNOCK SENSOR COMPONENTS FOR REMOVAL AND INSTALLATION

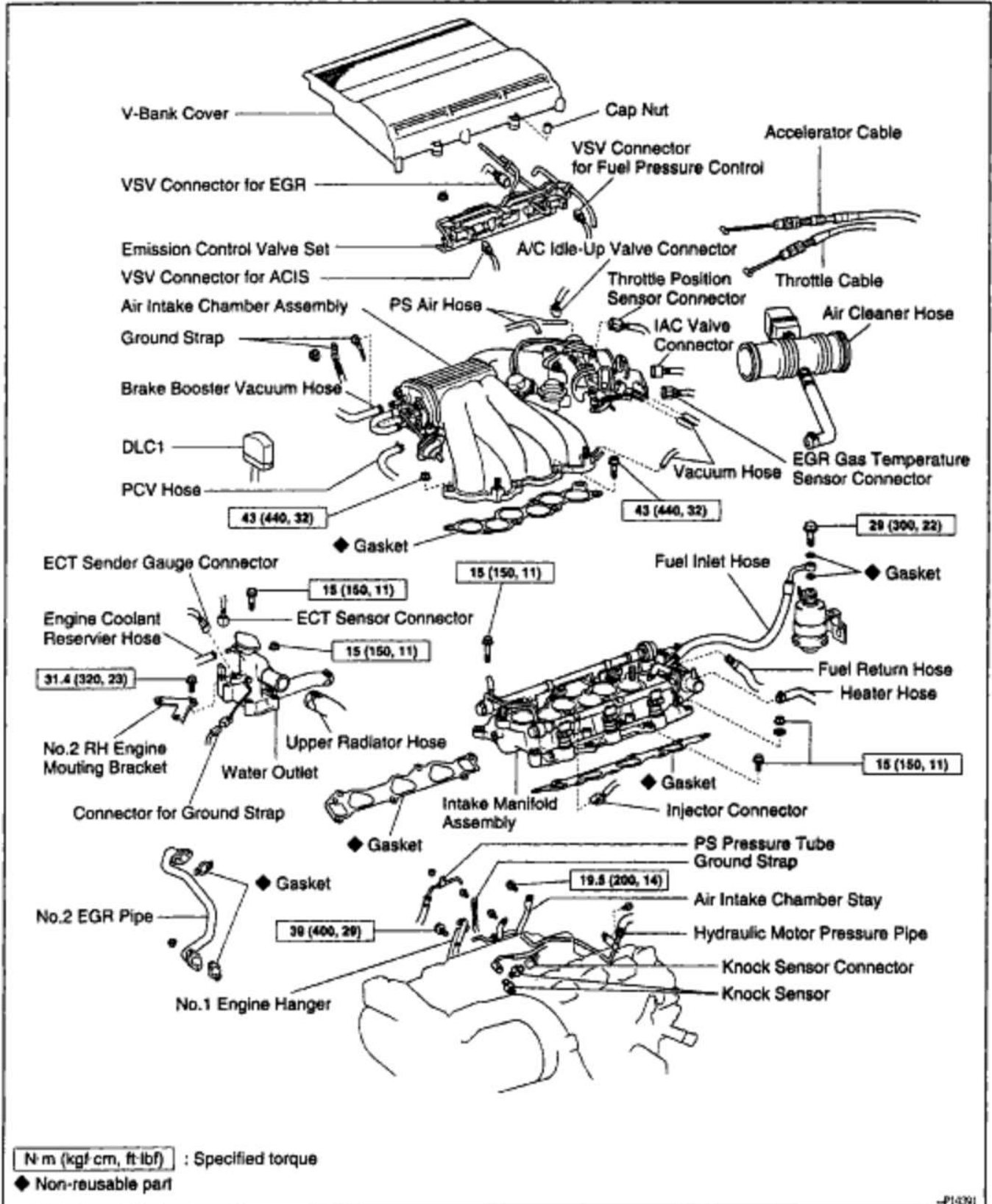

EG2-300

1MZ-FE ENGINE - SFI SYSTEM

INDEX-01

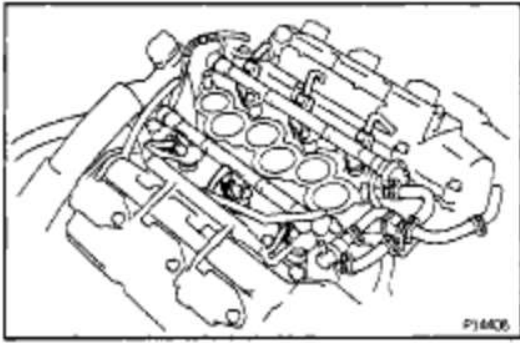
**KNOCK SENSORS INSPECTION**

(See Components for Removal and Installation)

1. REMOVE AIR INTAKE CHAMBER ASSEMBLY

(See steps 1 to 10 on pages EG2-246 to 249)

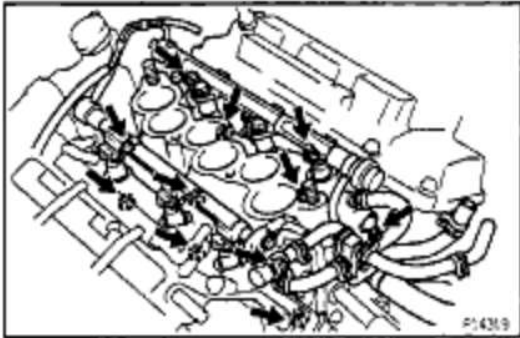
2. DISCONNECT INJECTOR CONNECTORS**3. REMOVE INTAKE MANIFOLD ASSEMBLY**

- (a) Disconnect the heater hose from the intake manifold.
- (b) Remove the 9 bolts, 2 nuts, 2 plates washers and intake manifold assembly.

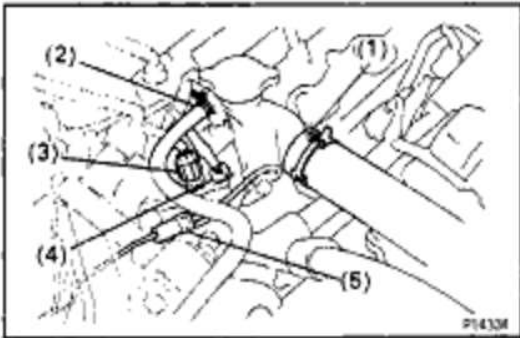
**4. REMOVE RH ENGINE MOUNTING STAY AND WATER OUTLET**

- (a) Disconnect the following hoses and connectors:
 - (1) Radiator inlet hose
 - (2) Engine coolant reservoir hose
 - (3) ECT sensor connector
 - (4) ECT switch connector
 - (5) Ground strap connector

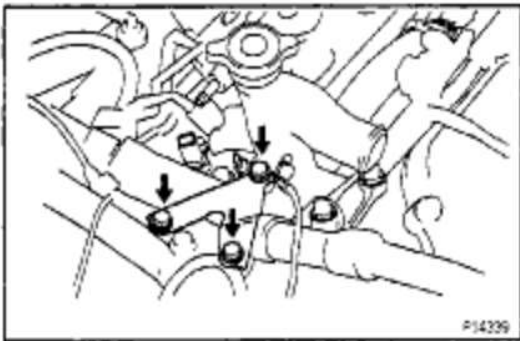

- (b) Remove the 3 bolts and RH mounting stay.

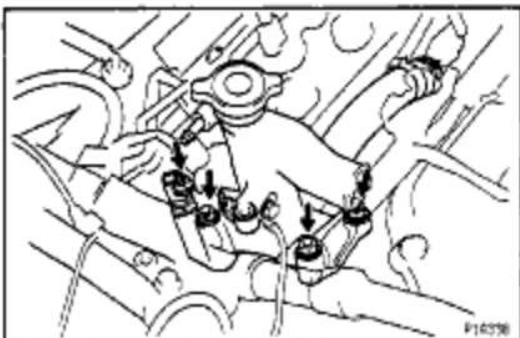

- (c) Remove the wire band.
- (d) Disconnect the water bypass hose from the inlet housing.
- (e) Remove the 2 bolts, 2 nuts, 2 plate washers and water outlet.



(f) Remove the 2 gaskets.

5. REMOVE KNOCK SENSORS

- (a) Disconnect the knock sensor connector.
- (b) Remove the knock sensor.

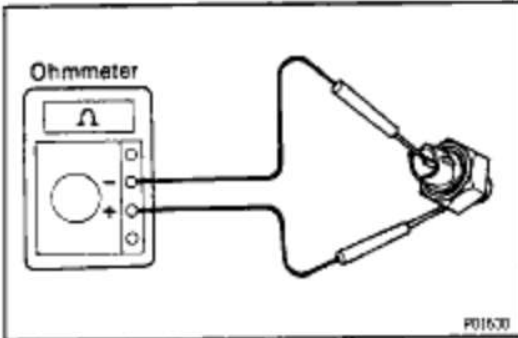

6. INSPECT KNOCK SENSORS

Using an ohmmeter, check that there is no continuity between the terminal and body.
If there is continuity, replace the sensor.



7. REINSTALL KNOCK SENSORS

- (a) Install the knock sensor.

Torque: 39 N-m (400 kgf-cm, 29 ft-lbf)

- (b) Connect the knock sensor connector.

8. REINSTALL WATER OUTLET AND RH ENGINE MOUNTING STAY

- (a) Install 2 new gaskets on the cylinder head.

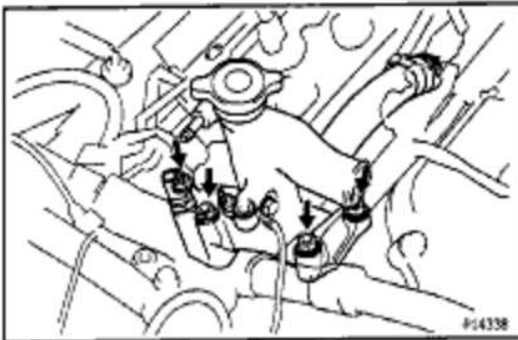

- (b) Install the water outlet with the the 2 bolts, 2 plate washers and 2 nuts.

Torque: 15 N-m (150 kgf-cm, 11 ft-lbf)

NOTICE: Do not scratch the seal surface of the water outlet with the stud bolt.

- (c) Connect the water bypass hose to the inlet housing.
- (d) Install the wire band.

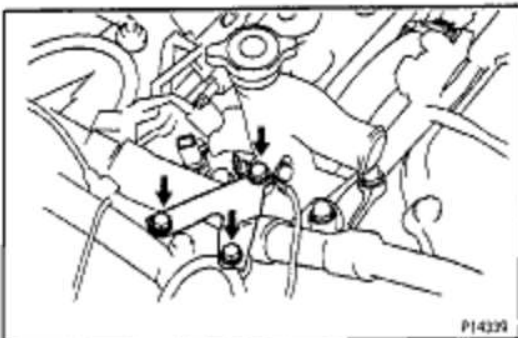

- (e) Install the RH mounting stay with the 3 bolts.

Torque: 31.4 N-m (320 kgf-cm, 23 ft-lbf)

EG2-302

1MZ-FE ENGINE - SFI SYSTEM

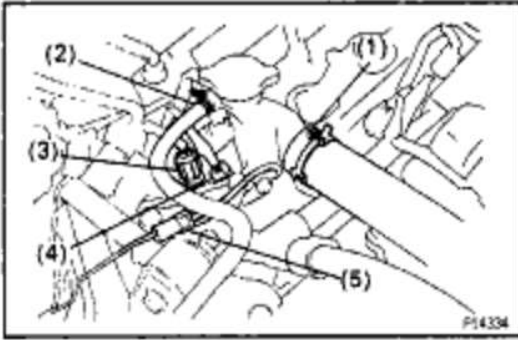

- (f) Connect the following hoses and connectors:
- (1) Radiator inlet hose
 - (2) Engine coolant reservoir hose
 - (3) ECT sensor connector
 - (4) ECT switch connector
 - (5) Ground strap connector

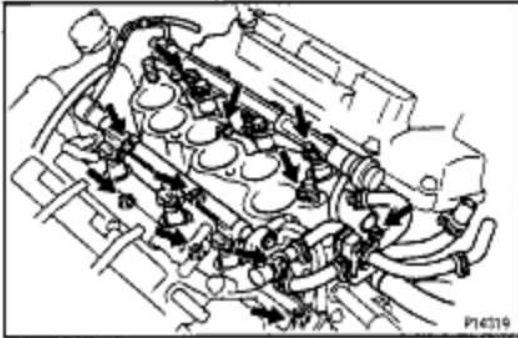
**9. REINSTALL INTAKE MANIFOLD ASSEMBLY**

- (a) Install the intake manifold assembly with the 9 bolts, 2 plate washers and 2 nuts.

Torque: 15 N-m (150 kgf-cm, 11 ft-lbf)

- (b) Connect the heater hose to the intake manifold.

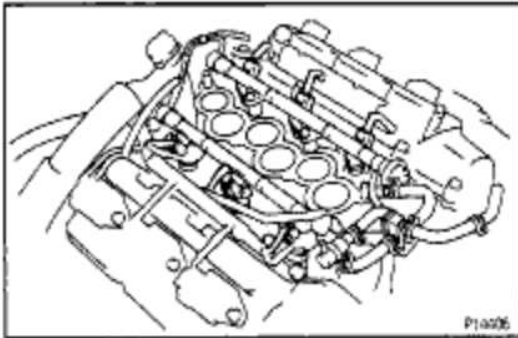
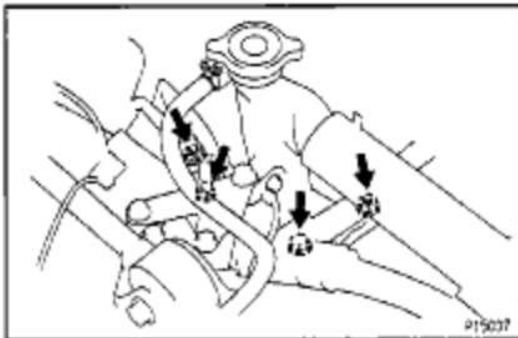
**10. RECONNECT INJECTOR CONNECTORS****11. RETIGHTENING WATER OUTLET MOUNTING BOLTS AND NUTS**

Torque: 15 N-m (150 kgf-cm, 11 ft-lbf)

12. REINSTALL AIR INTAKE CHAMBER ASSEMBLY

(See steps 5 to 14 on pages [EG2-254](#) to [257](#))

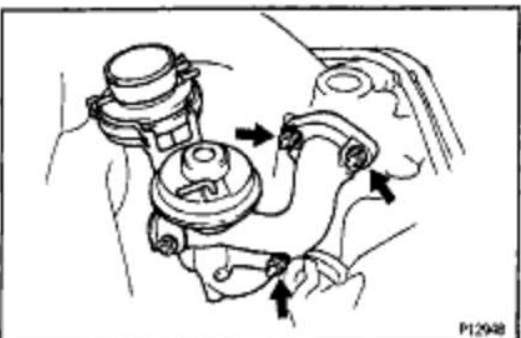
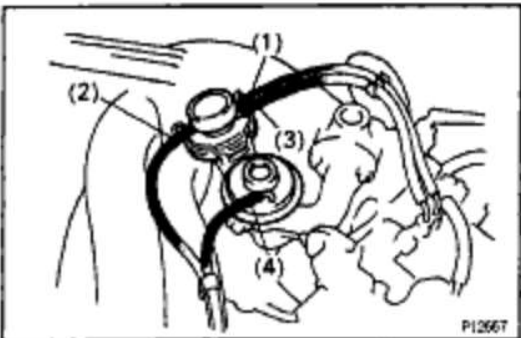
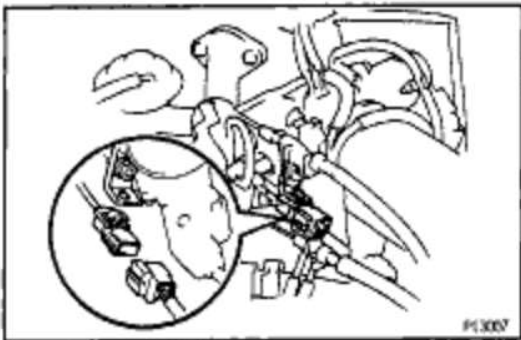
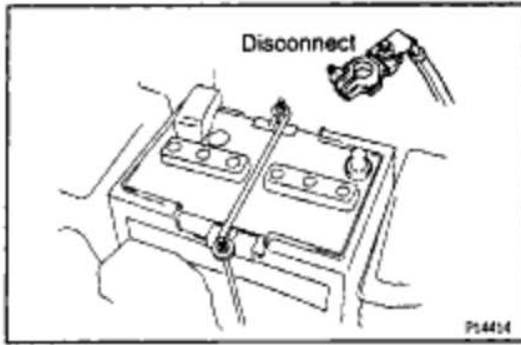

EGR GAS TEMPERATURE SENSOR

EGR GAS TEMPERATURE SENSOR INSPECTION

1. DISCONNECT NEGATIVE (-) TERMINAL CABLE FROM BATTERY

CAUTION: Work must be started after 90 seconds from the time the ignition switch is turned to the 'LOCK' position and the negative (-) terminal cable is disconnected from the battery.

2. REMOVE NO.2 EGR PIPE

Remove the 4 nuts, EGR pipe and 2 gaskets.

3. DISCONNECT EGR GAS TEMPERATURE SENSOR CONNECTOR AND CLAMP

4. REMOVE EGR VALVE AND VACUUM MODULATOR ASSEMBLY

(a) Disconnect the following hoses:

- (1) Vacuum hose from port P of EGR vacuum modulator
- (2) Vacuum hose from port Q of EGR vacuum modulator
- (3) Vacuum hose from port R of EGR vacuum modulator
- (4) Vacuum hose from EGR valve

(b) Remove the 3 nuts, EGR valve and vacuum modulator assembly and gasket.

EG2-304

1MZ-FE ENGINE - SFI SYSTEM

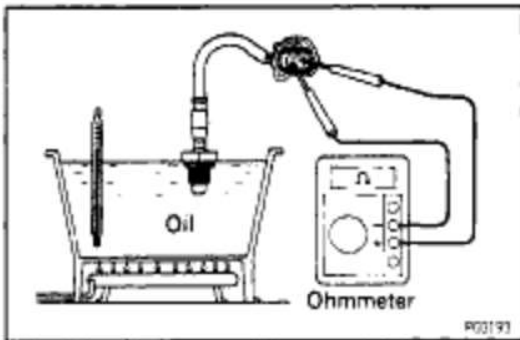
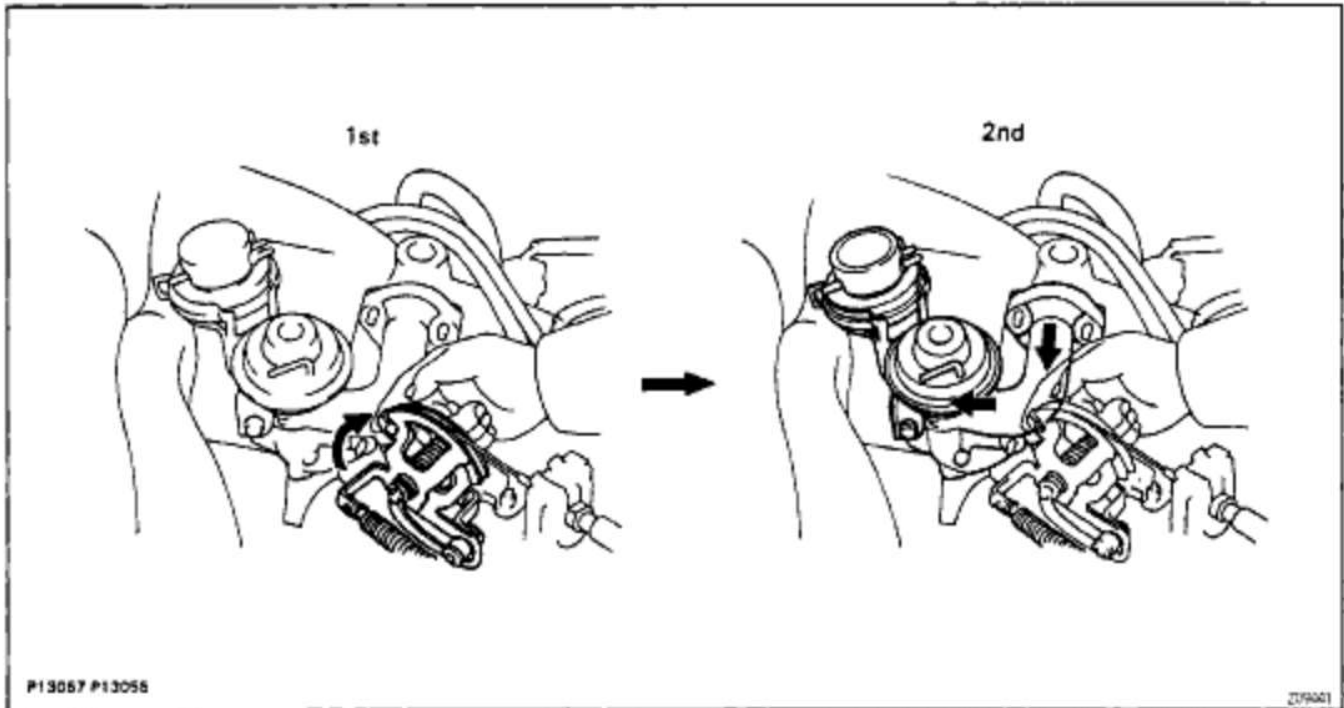
**5. REMOVE EGR GAS TEMPERATURE SENSOR****6. INSPECT EGR GAS TEMPERATURE SENSOR**

Using an ohmmeter, measure the resistance between the terminals.

Resistance:

64 – 97 k at 50₂C (112₂F)

11 – 16 k et 100₂C (212₂F)

2 – 4 k at 150₂C (302₂F)

If the resistance is not as specified, replace the sensor.

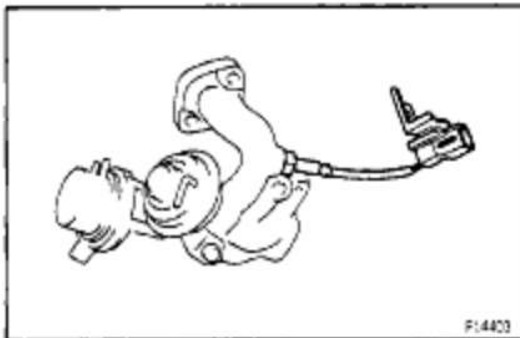
**7. REINSTALL EGR GAS TEMPERATURE SENSOR**

Torque: 20 N-m (200 kgf-cm, 14 ft-lbf)

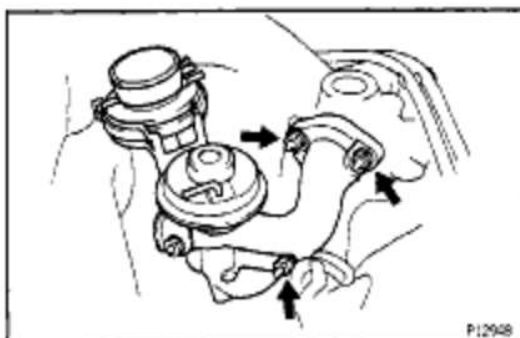
**8. REINSTALL EGR VALVE AND VACUUM MODULATOR ASSEMBLY**

(a) Install the EGR valve and vacuum modulator assembly with the 3 nuts.

Torque: 12 N-m (120 kgf-cm, 9 ft-lbf)

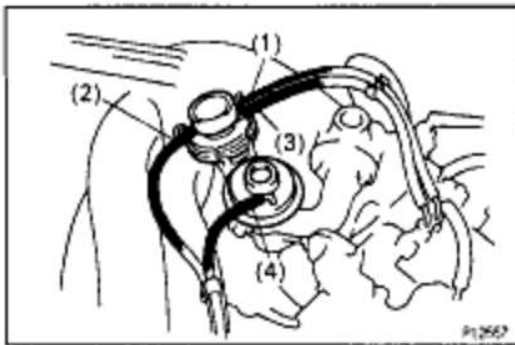
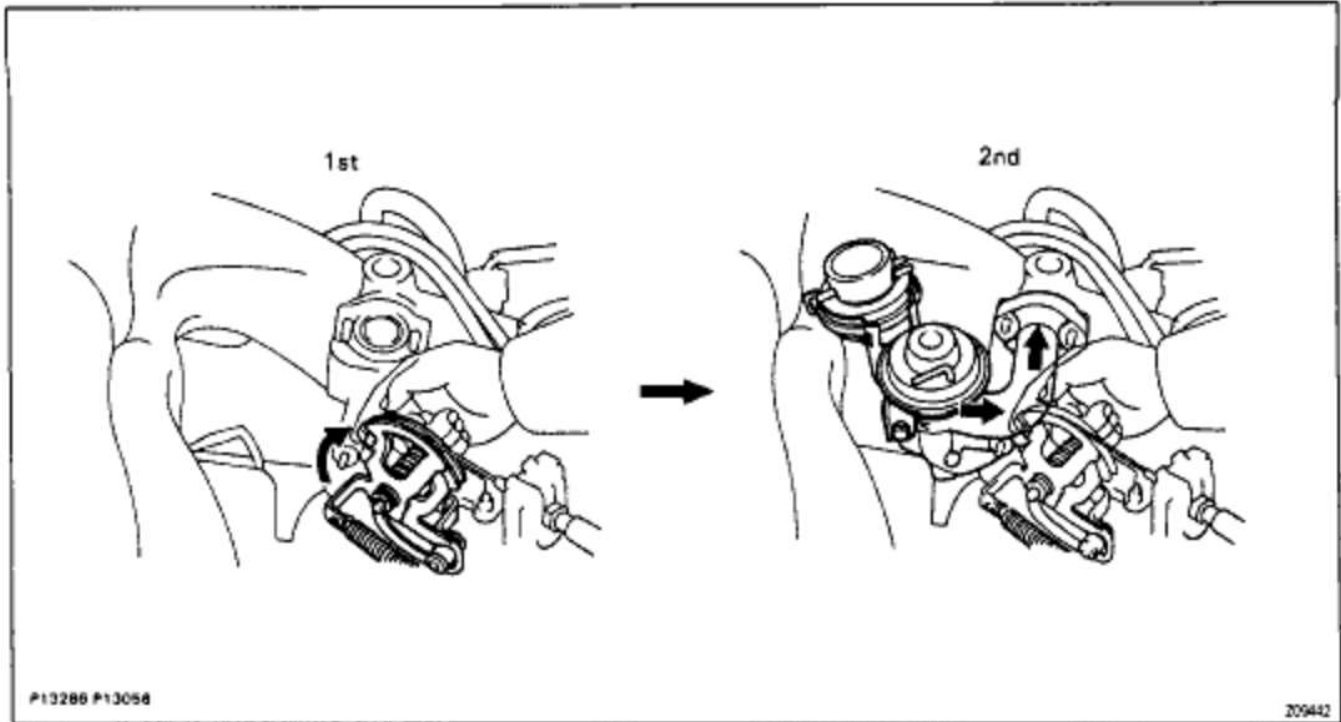

- (b) Connect the following vacuum hoses:
- (1) Vacuum hose to port P of EGR vacuum modulator
 - (2) Vacuum hose to port Q of EGR vacuum modulator
 - (3) Vacuum hose to port R of EGR vacuum modulator
 - (4) Vacuum to EGR valve

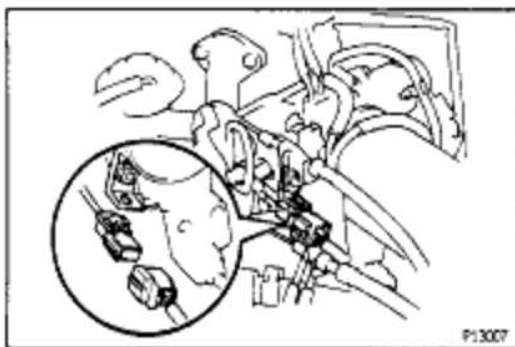

9. RECONNECT EGR GAS TEMPERATURE SENSOR CONNECTOR AND CLAMP



10. REINSTALL NO.2 EGR PIPE

Install 2 new gaskets and the EGR pipe with the 4 nuts.

Torque: 12 N-m (120 kgf-cm, 9 ft-lbf)

11. RECONNECT NEGATIVE (-) TERMINAL CABLE TO BATTERY

EG2-306

1MZ-FE ENGINE - SFI SYSTEM

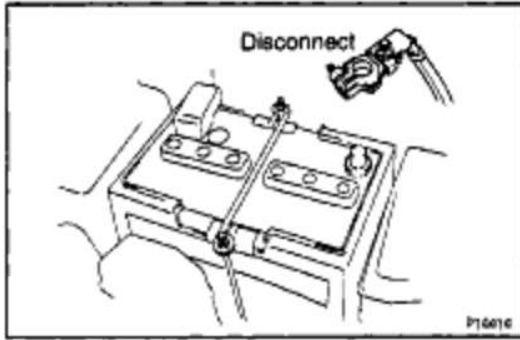

OXYGEN SENSOR

OXYGEN SENSORS INSPECTION

1. DISCONNECT NEGATIVE (-) TERMINAL CABLE FROM BATTERY

CAUTION: Work must be started after 90 seconds from the time the ignition switch is turned to the 'LOCK' position and the negative (-) terminal cable is disconnected from the battery.

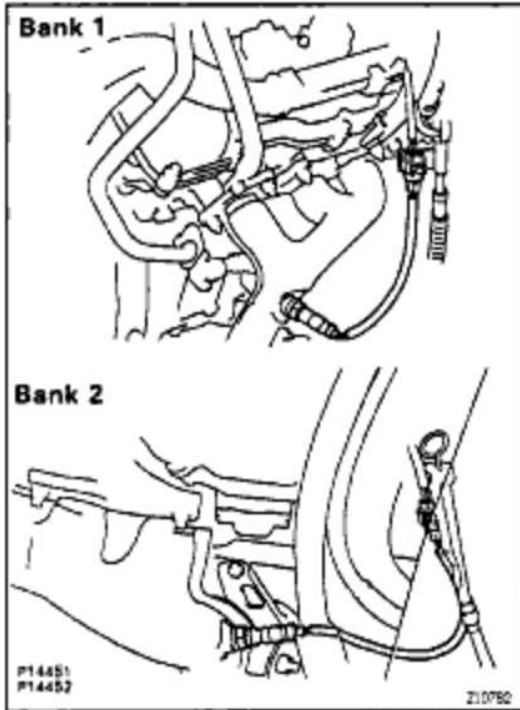

2. INSPECT HEATER RESISTANCE OF MAIN HEATED OXYGEN SENSORS

(a) Disconnect the oxygen sensor connectors.

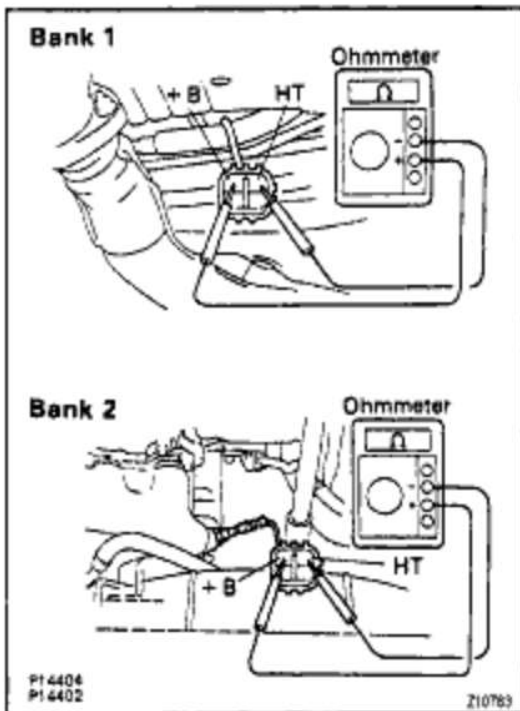

(b) Using an ohmmeter, measure the resistance between the terminals + B and HT.

Resistance:

11 – 16Ω at 20₂ C (68₂ F)

If the resistance is not as specified, replace the sensor.

Torque: 44 N-m (450 kgf-cm, 31 ft-lbf)

(c) Reconnect the oxygen sensor connectors.

3. RECONNECT NEGATIVE (-) TERMINAL CABLE TO BATTERY

Sub Heated Oxygen Sensor COMPONENTS FOR REMOVAL AND INSTALLATION

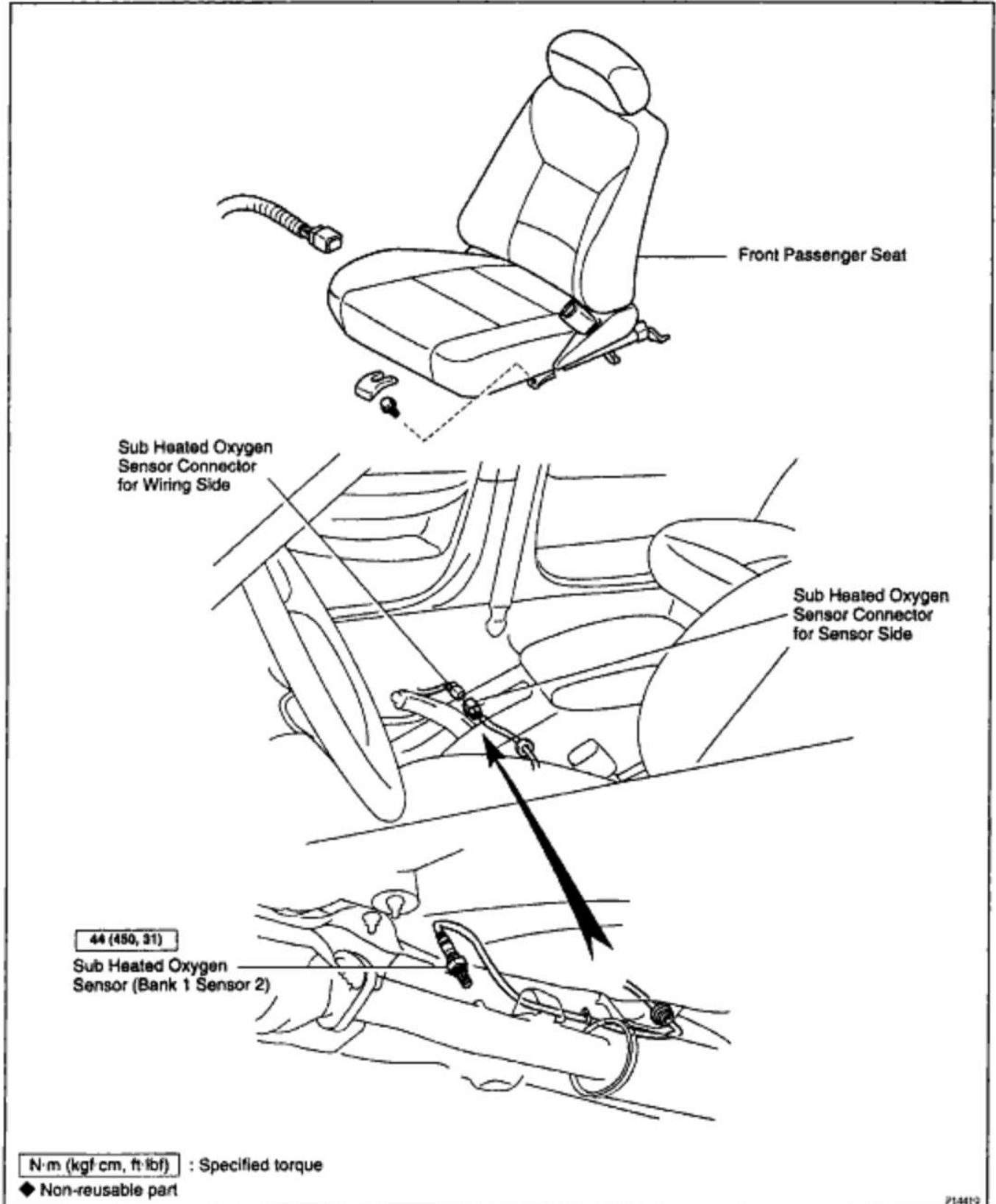

EG2-308

1MZ-FE ENGINE - SFI SYSTEM

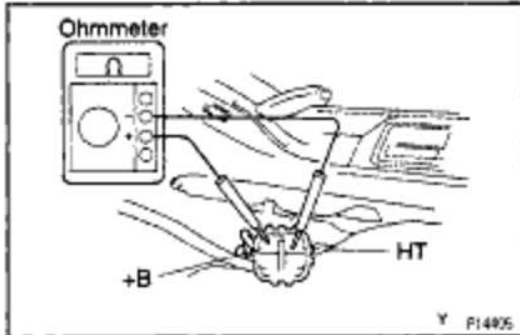
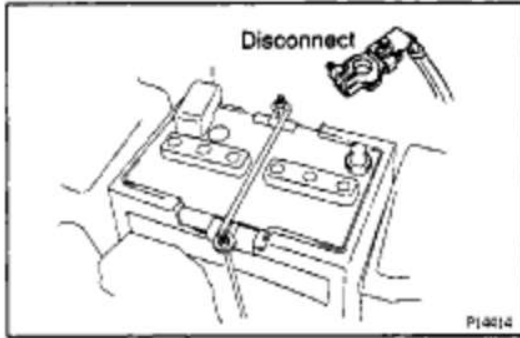

OXYGEN SENSOR INSPECTION

SFI+SYSTEM

(See Components for Removal and Installation)

1. DISCONNECT NEGATIVE (-) TERMINAL CABLE FROM BATTERY

CAUTION: Work must be started after 90 seconds from the time the ignition switch is turned to the 'LOCK' position and the negative (-) terminal cable is disconnected from the battery.

2. INSPECT HEATER RESISTANCE OF SUB HEATED OXYGEN SENSOR

- (a) Remove the passenger's seat.
- (b) Take out the consol box side of the floor carpet.
- (c) Disconnect the oxygen sensor connector.
- (d) Using an ohmmeter, measure the resistance between the terminals + B and HT.

Resistance:

11 - 16 at 20₂ C (68₂ F)

If the resistance is not as specified, replace the sensor.

- (e) Reconnect the oxygen sensor connector.
- (f) Reinstall the floor carpet.
- (g) Reinstall the passenger's seat.

3. RECONNECT NEGATIVE (-) TERMINAL CABLE TO BATTERY

1MZ-FE ENGINE –

-Memo

EG2-310

1MZ-FE ENGINE - SFI SYSTEM

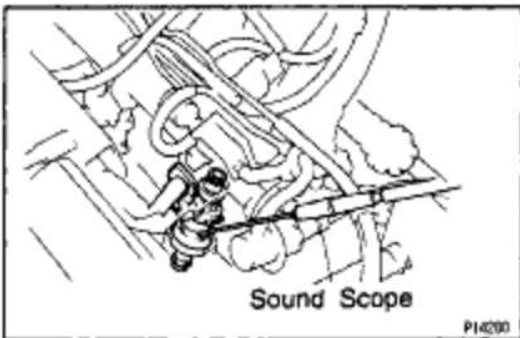
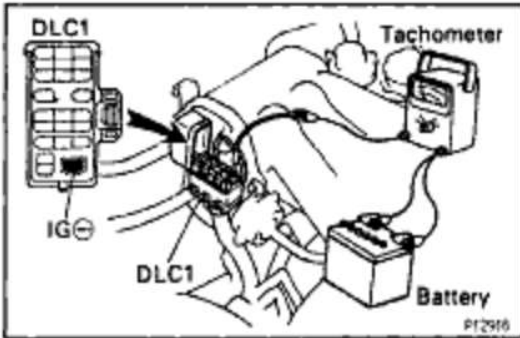
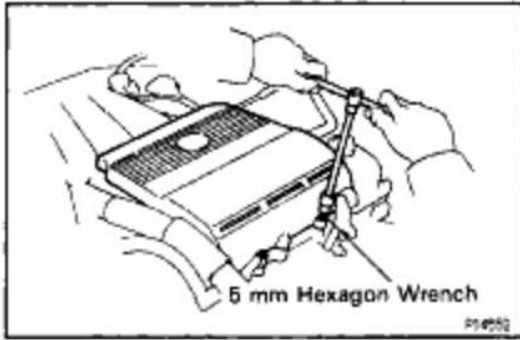
**FUEL CUT RPM****FUEL CUT OFF INSPECTION****1. REMOVE V- BANK COVER**

Using a 5 mm hexagon wrench, remove the 2 cap nuts and V-bank cover.

2. WARM UP ENGINE

Allow the engine to warm up to normal operating temperature.

3. CONNECT TACHOMETER TO ENGINE

Connect the test probe of a tachometer to terminal IG (1) of the DLC1.

NOTICE:

- **NEVER** allow the tachometer terminal to touch ground as it could result in damage to the igniter and/or ignition coil.
- As some tachometers are not compatible with this ignition system, we recommend that you confirm the compatibility of your unit before use.

4. INSPECT FUEL CUT OFF PRM

- Increase the engine speed to at least 3,500 rpm.
 - Use a sound scope to check for injector operating noise.
 - Check that when the throttle lever is released, injector operation noise stops momentarily and then resumes.
- HINT: Measure with the A/C OFF.

Fuel return rpm:

1,200 rpm

5. DISCONNECT TACHOMETER**6. REINSTALL V-BANK COVER**

Using a 5 mm hexagon wrench, install the V-bank cover with the 2 cap nuts.

HINT: For fixing the V-bank cover, push on the cover until sense of "click" is felt.

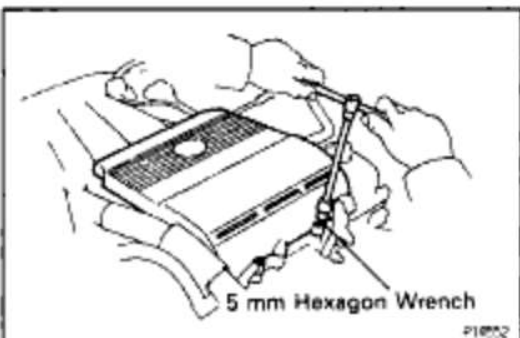

SERVICE SPECIFICATIONS

BMW-16

SERVICE DATA

Fuel pressure regulator	Fuel pressure at no vacuum	285 - 304 kPa (2.7 - 3.1 kgf/cm ² , 38 - 44 psi)
Fuel pump	Resistance at 20°C (68°F)	0.2 - 3.0 Ω
Injector	Resistance Injection volume Difference between each cylinder Fuel leakage	Approx. 13.8 Ω 54 - 64 cm ³ (3.5 - 3.9 cu in.) per 15 sec. 5 cm ³ (0.31 cu in.) or less 1 drop or less per minute
MAF meter	Resistance (THA - E2) at -20°C (-4°F) at 0°C (32°F) at 20°C (68°F) at 40°C (104°F) at 60°C (140°F)	10 - 20 kΩ 4 - 7 kΩ 2 - 3 kΩ 0.9 - 1.3 kΩ 0.4 - 0.7 kΩ
Throttle body	Throttle body fully closed angle Throttle opener setting speed	10° 900 - 1,950 rpm
Throttle position sensor	Clearance between stop screw and lever 0 mm (0 in.) VTA - E2 0.35 mm (0.014 in.) IDL - E2 0.70 mm (0.028 in.) IDL - E2 Throttle valve fully open VTA - E2 - VC - E2	0.28 - 6.4 kΩ 0.5 kΩ or less Infinity 2.0 - 11.6 kΩ 2.7 - 7.7 kΩ
IAC valve	Resistance + B - RSO (or RSC)	19.3 - 22.3 Ω
VSV for Fuel pressure control	Resistance at 20°C (68°F)	33 - 39 Ω
VSV for ACIS	Resistance at 20°C (68°F)	33 - 39 Ω
VSV for EGR	Resistance at 20°C (68°F)	33 - 39 Ω
A/C idle-up valve	Resistance at 20°C (68°F)	30 - 33 Ω
ECT sensor	Resistance at -20°C (-4°F) at 0°C (32°F) at 20°C (68°F) at 40°C (104°F) at 60°C (140°F) at 80°C (176°F)	10 - 20 kΩ 4 - 7 kΩ 2 - 3 kΩ 0.9 - 1.3 kΩ 0.4 - 0.7 kΩ 0.2 - 0.4 kΩ
EGR gas temperature sensor	Resistance at 50°C (122°F) at 100°C (212°F) at 150°C (302°F)	64 - 97 kΩ 11 - 18 kΩ 2 - 4 kΩ
Main heated oxygen sensor	Heater coil resistance at 20°C (68°F)	11 - 16 Ω
Sub heated oxygen sensor	Heater coil resistance at 20°C (68°F)	11 - 16 Ω
Fuel cut rpm	Fuel return rpm	1,200 rpm

EG2-312

1MZ-FE ENGINE - SFI SYSTEM

8812-04

TORQUE SPECIFICATIONS

Part tightened	N·m	kgf·cm	ft·lbf
Fuel line (Union bolt type)	29	300	22
Fuel line (Flare nut type for fuel pump side)	28	285	21
Fuel line (Flare nut type for others)	30	310	22
Fuel tank band x Body	39	400	29
Fuel pump x Fuel tank	4	40	35 in·lbf
Fuel pressure regulator x Delivery pipe	8	80	69 in·lbf
Delivery pipe x Cylinder head	10	100	7
No.1 fuel pipe x Intake manifold	19.5	200	14
No.2 fuel pipe x Delivery pipe	19.5	200	14
Air intake chamber x Intake manifold	43	440	32
EGR pipe x EGR vacuum modulator	12	120	9
EGR pipe x RH exhaust manifold	12	120	9
No. 1 engine hanger x Air intake chamber	39	400	29
Air intake chamber stay x Air intake chamber	19.5	200	14
Ground stop x Intake air control valve	14.5	145	10
Emission control valve set x Air intake chamber	8	80	69
MAF meter x Air cleaner	6.9	70	61
Throttle body x air intake chamber	19.5	200	14
Intake air control valve x Air intake chamber	14.5	145	10
ECT switch x Water outlet	20	200	14
Knock sensor x Cylinder head	39	400	29
Water outlet x Cylinder head	15	150	11
RH engine mounting stay x Water outlet	31.4	320	23
RH engine mounting stay x No.2 RH engine mounting bracket	31.4	320	23
Intake manifold x Cylinder head	15	150	11
EGR gas temperature sensor x EGR valve	20	200	14
EGR valve x Air intake chamber	12	120	9
Main heated oxygen sensor x Exhaust manifold	44	450	31
Sub heated oxygen sensor x Exhaust pipe	44	450	31